

# Trust Bartuf

For all your retail display solutions

INTRODUCING  
**C+4**  
&  
**FLEXI-NEWS™**



Standard Products Brochure Effective from June 2017

**Bartuf**<sup>®</sup>  
Quality Retail Solutions

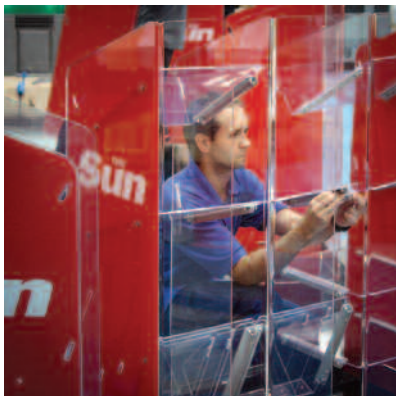

Bartuf is one of the UK's leading manufacturers of retail displays, providing high quality, innovative solutions for news, magazines, confectionery, greeting cards and much more to the biggest names in retail.

---

Established in 1995, Bartuf offers expertise in the design, manufacture and installation of display solutions via its UK production facilities.

Bartuf's multimillion pound turnover business has been built around the provision of the very best customer service which is reflected in its long standing client relationships.

Bartuf's portfolio of off-the-shelf solutions are all manufactured from polyester – a material which is 100% recyclable, highly durable and very eco-friendly. The extensive range of display equipment allows flexibility and choice when it comes to creating your in store selling space.

The products in this brochure have been designed to offer you the very best retail display solutions in all categories. With a large range of innovative displays from wall and gondola bays to dedicated freestanding displays we are confident you will find something to match your requirements.

---

**If your project requires a bespoke approach, our highly experienced in-house design team can work with you to develop your ideas into a viable solution that will deliver on maximum return once in-store.**

---

# Contents

<b>Magazines</b>	<b>3</b>	<b>Greetings Cards</b>	<b>32</b>
Magazine Bays	4	Greetings Cards Shelving	32
Inverted Base Trays	6	Greetings Cards Bays	33
Magazine Shelving	8	Greetings Cards Accessories	34
Magazine Accessories	12		
Magazines Freestanding	13	<b>Gondola Side Display</b>	<b>35</b>
		Gondola Side Frame	35
		Gondola Side Frame Accessories	36
<b>Newspapers</b>	<b>14</b>	<b>Queue Management</b>	<b>37</b>
Flexi-News	16	Queue Management System	38
Flexi-News Bays	17	Queue Management Accessories	39
News Shelving	17		
Forecourt Range	18	<b>BARliteLED™</b>	<b>41</b>
Flexi-News Freestanding	19	Illumination	42
Flexi News Cross Category	20		
News Freestanding	21		
Outside News	22		
<b>Confectionery</b>	<b>23</b>		
Confectionery Bays	24		
Confectionery Shelving	25		
Confectionery Counter Front / Freestanding	26		
<b>Snacking</b>	<b>27</b>		
Snacking Bays & Shelving	28		
Snacking Shelving	29		
Snacking Bins	30		
Confectionery & Snacking Bays	31		

**No Returns:** Under our standard terms and conditions we do not accept return of goods. Any items to be returned **must be agreed by the business;** prior to the products being returned and only in exceptional circumstances. We do not accept returns of items that have been cut to a specific size.

**Powder Coating Charges:** Powder coating charges will apply for any products required in a specific colour, which are not included in our latest brochure; subject to quotation. Please e-mail Bartuf with your request.

## Next day despatch

Many of our products are available as next day despatch when ordered before 12.00. Look out for the product codes highlighted in green.

For all other products, availability will be stated at point of order. Please see order acknowledgement for confirmation.

**S** May require up to 3 week leadtime.

## Guide for Bartuf standard UK carriage charges for bays or larger items

- B1** Unit Packed in 1 Box
- B2** Unit Packed in 2 Boxes
- F1** Freestanding Unit - Pack 1
- F2** Freestanding Unit - Pack 2
- F3** Freestanding Unit - Pack 3
- F4** Freestanding Unit - Pack 4
- P1** Pallet Rate 1
- P2** Pallet Rate 2
- P3** Pallet Rate 3

Please refer to the published Standard UK Carriage Charges for current rates.

Smaller items will be packed several to a box or combined with larger items if ordered together.

Standard delivery is between 8.30am and 5.30pm, Monday to Friday, to central mainland UK address.

We will be pleased to arrange timed or special deliveries, please refer to the Carriage Charges for current rates.

**Please note:** We reserve the right to discontinue or amend the specifications of products at our discretion. All brackets are supplied in cream RAL9001 finish unless otherwise stated. Other colours available subject to quotation.

All product designs are protected by design rights & copyright ©  
Patents: GB 2293538B, GB2317328, US 6,112,912



# Magazines

## Leading In Store Displays

Magazines, by their very nature, demand a lot of in store space if you are to display a comprehensive range. As with many categories, when allocating this space you need to make sure your display is working as hard as possible.

You also need to take into account the mix of categories within the magazine sector in relation to bestsellers and specialist titles and also weekly and monthly publications. This creates conflicting needs for both high range displays and high volume shelving. Quite often, one display does not suit all.



The BARliteLED™ range of products, specialising in retail display lighting, is a high quality solution which brings a retail environment to life and creates a modern look to your store design whilst keeping running costs to a minimum.

### The Right Decision

Built on years of industry knowledge and working with some of the leading retailers and wholesalers, Bartuf have developed a large range of shelving options and bay configurations to help you get the ultimate magazine display for your store.

All hang-on shelving systems carry our unique 5 year guarantee (subject to our standard conditions)

Increase sales by adding LED illumination (see page 41 for details)



## 8 Tier Super

B1

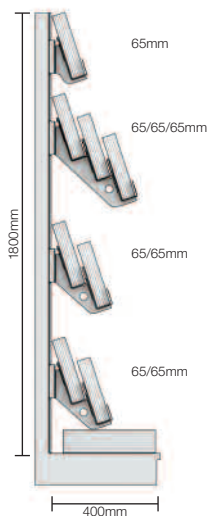

<b>8</b>	Tier Display
<b>32</b>	Facings (1000mm bay width)
<b>520</b>	mm Profile volume

Bracket colour: Cream RAL9001

Width	Code	Price
600mm	A011001	£236.70
650mm	A071019	£274.20
900mm	A021002	£301.75
1000mm	<b>A031001</b>	£301.75
1200mm	A041001	£333.40
1250mm	A051002	£362.90
1330mm	A061002	£385.95

Bracket colour: Silver RAL9006

Width	Code	Price
600mm	A011256	£236.70
650mm	A072062	£274.20
900mm	A021240	£301.75
1000mm	A031638	£301.75
1200mm	A041329	£333.40
1250mm	A051253	£362.90
1330mm	A061174	£385.95

Bracket colour: Grey RAL9007

Width	Code	Price
600mm	A011191	£236.70
650mm	A072255	£274.20
900mm	A021250	£301.75
1000mm	A031561	£301.75
1200mm	A041231	£333.40
1250mm	A051331	£362.90
1330mm	A061189	£385.95

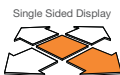

## 8 Tier Super Plus

B1

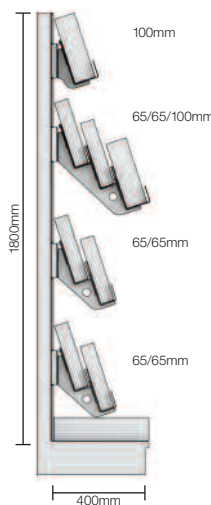

<b>8</b>	Tier Display
<b>32</b>	Facings (1000mm bay width)
<b>590</b>	mm Profile volume

Bracket colour: Cream RAL9001

Width	Code	Price
600mm	A011076	£240.50
650mm	A071492	£283.60
900mm	A021319	£305.60
1000mm	<b>A031124</b>	£305.60
1200mm	A041083	£339.35
1250mm	A051074	£377.70
1330mm	A061057	£400.90

Bracket colour: Silver RAL9006

Width	Code	Price
600mm	A011366	£240.50
650mm	A072635	£283.60
900mm	A021348	£305.60
1000mm	A032279	£305.60
1200mm	A041426	£339.35
1250mm	A051449	£377.70
1330mm	A061298	£400.90

Bracket colour: Grey RAL9007

Width	Code	Price
600mm	A011368	£240.50
650mm	A072637	£283.60
900mm	A021350	£305.60
1000mm	A032281	£305.60
1200mm	A041428	£339.35
1250mm	A051451	£377.70
1330mm	A061300	£400.90



## 9 Tier Super

B1

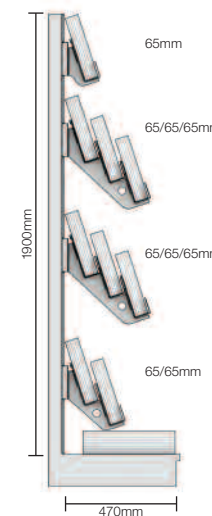

<b>9</b>	Tier Display
<b>36</b>	Facings (1000mm bay width)
<b>585</b>	mm Profile volume

Bracket colour: Cream RAL9001

Width	Code	Price
600mm	A011005	£262.00
650mm	A071069	£296.10
900mm	A021006	£334.25
1000mm	<b>A031005</b>	£334.25
1200mm	A041005	£371.85
1250mm	A051006	£394.50
1330mm	A061006	£420.35

Bracket colour: Silver RAL9006

Width	Code	Price
600mm	A011259	£262.00
650mm	A072028	£296.10
900mm	A021243	£334.25
1000mm	A031293	£334.25
1200mm	A041177	£371.85
1250mm	A051244	£394.50
1330mm	A061177	£420.35

Bracket colour: Grey RAL9007

Width	Code	Price
600mm	A011268	£262.00
650mm	A071694	£296.10
900mm	A021253	£334.25
1000mm	A031219	£334.25
1200mm	A041158	£371.85
1250mm	A051333	£394.50
1330mm	A061192	£420.35



### Increase sales by adding LED illumination

(see page 41 for details)

Products highlighted green are available for next day despatch  
Please quote codes on all orders. Other sizes are available subject to quotation  
Backing systems not included  
Other bay / shelf widths available upon request

Prices shown are Recommended Retail Price (RRP) and subject to discount, contact sales for a quotation

## 9 Tier Super Plus

B1

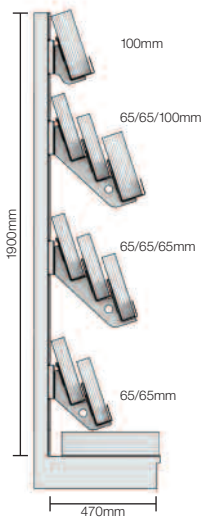

9	Tier Display
36	Facings (1000mm bay width)
655	mm Profile volume

Bracket colour: Cream RAL9001

Width	Code	Price
600mm	A011006	£265.30
650mm	A071081	£305.85
900mm	A021008	£338.25
1000mm	A031006	£338.25
1200mm	A041006	£377.75
1250mm	A051008	£401.90
1330mm	A061008	£435.50

Bracket colour: Silver RAL9006

Width	Code	Price
600mm	A011260	£265.30
650mm	A071890	£305.85
900mm	A021244	£338.25
1000mm	A031634	£338.25
1200mm	A041239	£377.75
1250mm	A051248	£401.90
1330mm	A061178	£435.50

Bracket colour: Grey RAL9007

Width	Code	Price
600mm	A011269	£265.30
650mm	A072037	£305.85
900mm	A021254	£338.25
1000mm	A031683	£338.25
1200mm	A041269	£377.75
1250mm	A051230	£401.90
1330mm	A061193	£435.50

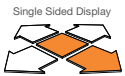

## 10 Tier Super Plus

B1

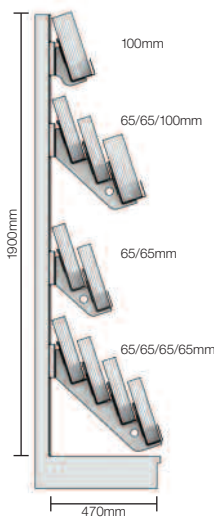

10	Tier Display
40	Facings (1000mm bay width)
720	mm Profile volume

Bracket colour: Cream RAL9001

Width	Code	Price
600mm	A011063	£278.50
650mm	A071490	£322.25
900mm	A021165	£360.30
1000mm	A031096	£360.30
1200mm	A041070	£402.45
1250mm	A051062	£437.80
1330mm	A061045	£465.25

Bracket colour: Silver RAL9006

Width	Code	Price
600mm	A011261	£278.50
650mm	A072249	£322.25
900mm	A021246	£360.30
1000mm	A031778	£360.30
1200mm	A041331	£402.45
1250mm	A051328	£437.80
1330mm	A061180	£465.25

Bracket colour: Grey RAL9007

Width	Code	Price
600mm	A011271	£278.50
650mm	A072258	£322.25
900mm	A021256	£360.30
1000mm	A031493	£360.30
1200mm	A041339	£402.45
1250mm	A051334	£437.80
1330mm	A061195	£465.25

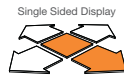

## 10 Tier High Volume

B1

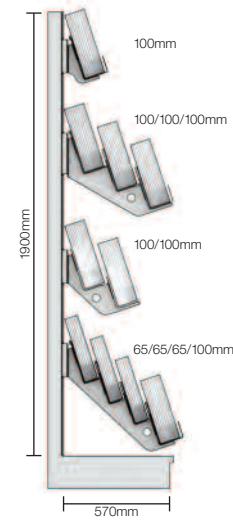

10	Tier Display
40	Facings (1000mm bay width)
895	mm Profile volume

Bracket colour: Cream RAL9001

Width	Code	Price
600mm	A011064	£319.80
650mm	A071489	£359.15
900mm	A021347	£403.95
1000mm	A031097	£403.95
1200mm	A041071	£440.95
1250mm	A051063	£477.00
1330mm	A061046	£504.40

Bracket colour: Silver RAL9006

Width	Code	Price
600mm	A011367	£319.80
650mm	A072636	£359.15
900mm	A021349	£403.95
1000mm	A032280	£403.95
1200mm	A041427	£440.95
1250mm	A051450	£477.00
1330mm	A061299	£504.40

Bracket colour: Grey RAL9007

Width	Code	Price
600mm	A011369	£319.80
650mm	A072638	£359.15
900mm	A021351	£403.95
1000mm	A032282	£403.95
1200mm	A041429	£440.95
1250mm	A051452	£477.00
1330mm	A061301	£504.40



Increase sales by adding LED illumination

(see page 41 for details)



## 11 Tier Super Plus + Base Tray B2

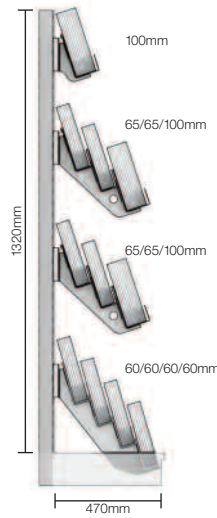

<b>11</b>	Tier Display
<b>44</b>	Facings (1000mm bay width)
<b>800</b>	mm Profile volume

Bracket colour: Cream RAL9001

Width	Code	Price
1000mm	A031909	£490.40
1250mm	A051324	£591.45

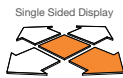

## 11 Tier High Volume + Base Tray B2

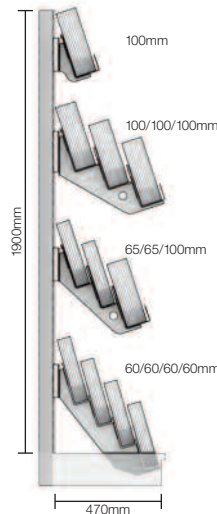

<b>11</b>	Tier Display
<b>44</b>	Facings (1000mm bay width)
<b>870</b>	mm Profile volume

Bracket colour: Cream RAL9001

Width	Code	Price
1000mm	A031897	£499.85
1250mm	A051321	£596.70

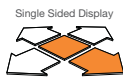

## 6 Tier Super Low Level Gondola B1

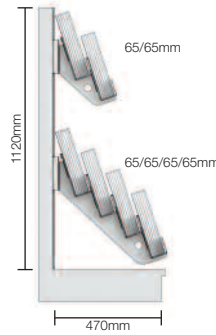

<b>6</b>	Tier Display
<b>24</b>	Facings (1000mm bay width)
<b>390</b>	mm Profile volume

Bracket colour: Cream RAL9001

Width	Code	Price
600mm	A011079	£173.40
650mm	A071495	£197.80
900mm	A021306	£222.85
1000mm	<b>A031127</b>	£222.85
1200mm	A041086	£247.20
1250mm	A051077	£266.45
1330mm	A061060	£282.35

Bracket colour: Silver RAL9006

Width	Code	Price
600mm	A011370	£173.40
650mm	A072639	£197.80
900mm	A021352	£222.85
1000mm	A032283	£222.85
1200mm	A041430	£247.20
1250mm	A051453	£266.45
1330mm	A061302	£282.35

Bracket colour: Grey RAL9007

Width	Code	Price
600mm	A011374	£173.40
650mm	A072642	£197.80
900mm	A021356	£222.85
1000mm	A032286	£222.85
1200mm	A041434	£247.20
1250mm	A051456	£266.45
1330mm	A061306	£282.35

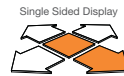

Slatwall  
adaptors sold  
individually  
K201132  
£6.90 each

## Inverted Base Trays

Increase display space in your metal backing system with a simple 'drop in' base tray.

To suit base depth **D**  
470-550mm

W	Width	Code	Price
1000mm	1000mm	K031210	£47.85
1250mm	1250mm	K051080	£65.80



Illustration showing base tray in backing system

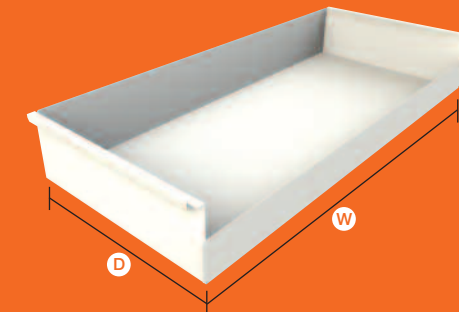

Please quote codes on all orders. Other sizes are available subject to quotation  
Backing systems not included  
Other bay / shelf widths available upon request

Prices shown are Recommended Retail Price (RRP) and subject to discount, contact sales for a quotation

## 6 Tier Super Gondola

B1

## 7 Tier Super Low Level Gondola

B1

## 7 Tier Super Gondola

B1

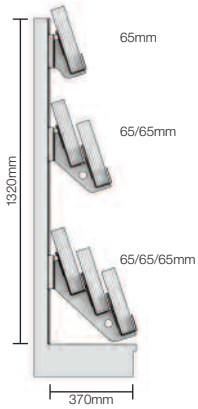

<b>6</b>	Tier Display
<b>24</b>	Facings (1000mm bay width)
<b>390</b>	mm Profile volume

Bracket colour: Cream RAL9001

Width	Code	Price
600mm	A011328	£179.55
650mm	A071496	£204.55
900mm	A021307	£227.85
1000mm	A031128	£227.85
1200mm	A041087	£251.55
1250mm	A051078	£269.25
1330mm	A061061	£286.95

Bracket colour: Silver RAL9006

Width	Code	Price
600mm	A011371	£179.55
650mm	A072271	£204.55
900mm	A021353	£227.85
1000mm	A031931	£227.85
1200mm	A041431	£251.55
1250mm	A051341	£269.25
1330mm	A061303	£286.95

Bracket colour: Grey RAL9007

Width	Code	Price
600mm	A011375	£179.55
650mm	A072643	£204.55
900mm	A021357	£227.85
1000mm	A032287	£227.85
1200mm	A041435	£251.55
1250mm	A051457	£269.25
1330mm	A061307	£286.95

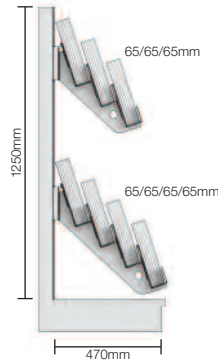
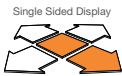

<b>7</b>	Tier Display
<b>28</b>	Facings (1000mm bay width)
<b>455</b>	mm Profile volume

Bracket colour: Cream RAL9001

Width	Code	Price
600mm	A011077	£197.85
650mm	A071493	£219.90
900mm	A021308	£255.25
1000mm	A031125	£255.25
1200mm	A041084	£284.75
1250mm	A051075	£298.05
1330mm	A061058	£316.40

Bracket colour: Silver RAL9006

Width	Code	Price
600mm	A011372	£197.85
650mm	A072640	£219.90
900mm	A021354	£255.25
1000mm	A032284	£255.25
1200mm	A041432	£284.75
1250mm	A051454	£298.05
1330mm	A061304	£316.40

Bracket colour: Grey RAL9007

Width	Code	Price
600mm	A011376	£197.85
650mm	A072644	£219.90
900mm	A021358	£255.25
1000mm	A032288	£255.25
1200mm	A041436	£284.75
1250mm	A051458	£298.05
1330mm	A061308	£316.40

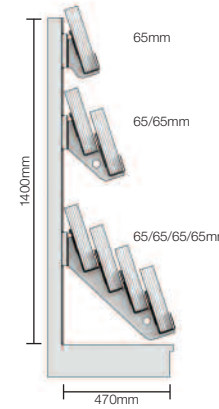
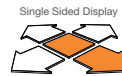

<b>7</b>	Tier Display
<b>28</b>	Facings (1000mm bay width)
<b>455</b>	mm Profile volume

Bracket colour: Cream RAL9001

Width	Code	Price
600mm	A011078	£212.30
650mm	A071494	£240.75
900mm	A021309	£268.95
1000mm	A031126	£268.95
1200mm	A041085	£296.05
1250mm	A051076	£316.80
1330mm	A061059	£336.40

Bracket colour: Silver RAL9006

Width	Code	Price
600mm	A011373	£212.30
650mm	A072641	£240.75
900mm	A021355	£268.95
1000mm	A032285	£268.95
1200mm	A041433	£296.05
1250mm	A051455	£316.80
1330mm	A061305	£336.40

Bracket colour: Grey RAL9007

Width	Code	Price
600mm	A011377	£212.30
650mm	A072645	£240.75
900mm	A021359	£268.95
1000mm	A032289	£268.95
1200mm	A041437	£296.05
1250mm	A051459	£316.80
1330mm	A061309	£336.40

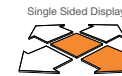

Increase sales by adding LED illumination  
(see page 41 for details)



# Why... Bartuf Magazine Shelving?



## 1 Largest shelving range

From 1 to 8 tier shelves and shelf depths from 35mm to 150mm, there are solutions for every magazine bay requirement.

## 2 Extensive range of display enhancements

From dividers to maintain excellent product presentation to category signage to help with in bay navigation.

## 3 Full face and multi tiered

High volume full face shelving for the bestsellers and lower volume multi tiered shelving for specialist titles.

## 4 Bay widths

Whatever your bay width, Bartuf's magazine shelving is designed to fit and make the most of the available space

## 5 One shelf, two brackets

The simplicity of the magazine shelving keeps installation times to a minimum.

## 6 Universal fitting

The hook detail on all Bartuf brackets has been designed to fit into the majority of backing structures found in today's retail environments. Our standard brackets even fit into 25mm pitch systems (on request) which are growing in popularity.

## 7 Illumination

The BARliteLED™ lighting system has been designed to easily fit to any Bartuf magazine shelf. Adding illumination not only brings a 'wow' factor to your display it is also proven to increase sales. See page 41.

# Magazine Shelving

Slatwall adaptors sold individually K201132 £6.90 each

## 1 Tier Magazines

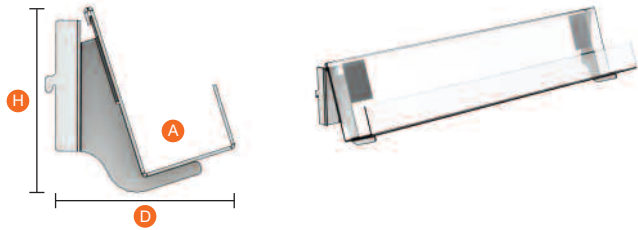

### Shelf Depth

### Shelf Dimensions H Height D Depth

### Shelf Widths

Shelf Depth	Shelf Dimensions		Shelf Widths						
	H Height	D Depth	600mm	650mm	900mm	1000mm	1200mm	1250mm	1330mm
A 65mm	205mm	165mm	A011007	A071099	A021010	A031007	A041007	A051010	A061010
			A011245	A071642	A021233	A031070	A041288	A051148	A061181
			A011272	A071781	A021184	A031488	A041249	A051335	A061196
			A011031	A071250	A021026	A031052	A041030	A051027	A061022
			£39.00	£42.95	£46.10	£46.10	£48.90	£50.30	£54.05
A 100mm	205mm	200mm	A011012	A071090	A021009	A031012	A041012	A051009	A061009
			A011049	A072250	A021247	A031049	A041332	A051206	A061151
			A011205	A072259	A021257	A031440	A041222	A051226	A061197
			A011036	A071241	A021025	A031057	A041035	A051026	A061021
			£39.75	£43.20	£47.30	£47.30	£51.95	£53.10	£56.65
A 120mm	205mm	215mm	G011025	G071079	G021009	G031017	G041019	G051003	G061002
			G011107	G071388	G021098	G031378	G041124	G051115	G061071
			POA	POA	POA	POA	POA	POA	POA
			£64.10	£72.35	£82.45	£82.45	£89.70	£96.00	£103.85

## 2 Tier Magazines

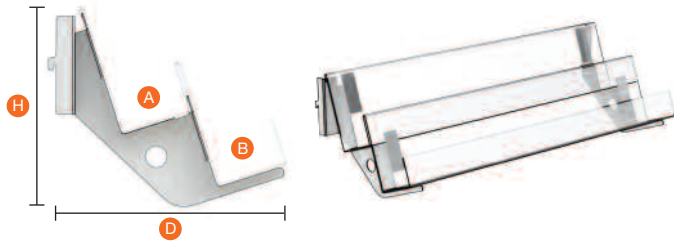

A 65/B 65mm	290mm	275mm	A011008	A071126	A021013	A031008	A041008	A051013	A061013
			A011046	A071645	A021232	A031026	A041242	A051149	A061182
			A011273	A071782	A021258	A031487	A041228	A051227	A061156
			£58.05	£69.75	£74.65	£74.65	£82.55	£93.65	£99.40
A 65/B 100mm	290mm	305mm	A011010	A071117	A021012	A031010	A041010	A051012	A061012
			A011262	A072251	A021197	A031050	A041333	A051191	A061152
			A011239	A071779	A021259	A031499	A041232	A051231	A061198
			£61.25	£72.10	£78.40	£78.40	£86.55	£96.45	£102.20
A 100/B 100mm	295mm	340mm	A011013	A071108	A021011	A031013	A041013	A051011	A061011
			A011044	A071813	A021037	A031062	A041051	A051190	A061183
			A011274	A072260	A021260	A031441	A041223	A051297	A061199
			£66.05	£80.50	£83.50	£83.50	£90.65	£105.25	£110.85

Bracket colour options: Cream RAL9001 Silver RAL9006 Grey RAL9007 Brackets to suit slatwall (Cream RAL9001)

## Increase sales by adding LED illumination

(see page 41 for details)

To calculate shelf spacing within a bay allow an additional 105mm above shelf height (H) to include magazine.  
All dimensions approximate.

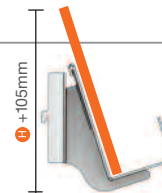

Products highlighted green are available for next day despatch  
Please quote codes on all orders. Other sizes are available subject to quotation  
Other bay / shelf widths available upon request

Prices shown are Recommended Retail Price (RRP) and subject to discount, contact sales for a quotation



# Magazine Shelving

Slatwall adaptors sold individually K201132 £6.90 each

## 3 Tier Magazines

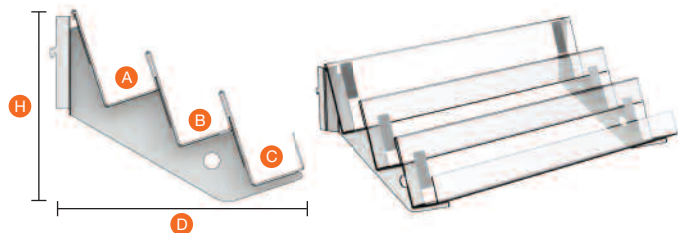

### Shelf Depth

### Shelf Dimensions

H Height D Depth

### Shelf Widths

600mm 650mm 900mm 1000mm 1200mm 1250mm 1330mm

Shelf Depth	Shelf Dimensions	Shelf Widths						
	H Height D Depth	600mm	650mm	900mm	1000mm	1200mm	1250mm	1330mm
A 65/ B 65/ C 65mm	390mm 390mm	A011009	A071152	A021016	A031009	A041009	A051016	A061016
		A011057	A071646	A021048	A031031	A041241	A051150	A061153
		A011275	A071783	A021261	A031410	A041227	A051229	A061157
		£82.55	£91.85	£107.10	£107.10	£120.10	£125.25	£133.50
A 65/ B 65/ C 100mm	390mm 420mm	A011011	A071141	A021015	A031011	A041011	A051015	A061015
		A011051	A071764	A021039	A031065	A041245	A051266	A061155
		A011238	A071778	A021262	A031495	A041224	A051228	A061200
		£85.35	£101.65	£109.75	£109.75	£123.05	£137.90	£146.20
A 65/ B 100/ C 100mm	390mm 455mm	A011048	A071351	A021040	A031018	A041045	A051022	A061030
		POA	POA	POA	POA	POA	POA	POA
		POA	POA	POA	POA	POA	POA	POA
		£93.65	£106.10	£119.30	£119.30	£132.65	£143.20	£150.30
A 100/ B 100/ C 100mm*	370mm 480mm	A011014	A071135	A021014	A031014	A041014	A051014	A061014
		A011050	A071812	A021038	A031048	A041054	A051207	A061184
		A011276	A072261	A021263	A031442	A041225	A051298	A061201
		£97.00	£109.75	£123.45	£123.45	£132.00	£144.30	£152.50

## 4 Tier Magazines

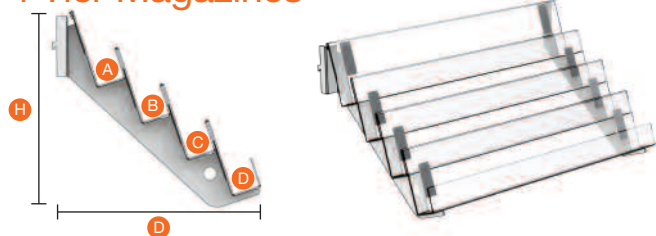

A 65/ B 65/ C 65/ D 65mm	480mm 490mm	A011052	A071515	A021041	A031073	A041046	A051023	A061023
		A011058	A072185	A021049	A031080	A041053	A051235	A061185
		A011237	A071826	A021264	A031563	A041230	A051336	A061158
		£115.30	£128.05	£148.20	£148.20	£164.65	£172.75	£182.90
A 65/ B 65/ C 65/ D 100mm	480mm 520mm	A011059	A071499	A021050	A031081	A041055	A051040	A061041
		A011264	A072253	A021248	A031884	A041335	A051329	A061187
		A011278	A072263	A021266	A031886	A041341	A051338	A061203
		£117.70	£126.45	£150.45	£150.45	£167.00	£175.10	£185.10

### Increase sales by adding LED illumination

(see page 41 for details)

Bracket colour options: ● Cream RAL9001 ● Silver RAL9006 ● Grey RAL9007

Products highlighted green are available for next day despatch  
Other bay / shelf widths available upon request

Prices shown are Recommended Retail Price (RRP) and subject to discount, contact sales for a quotation

Slatwall adaptors sold individually K201132 £6.90 each

### 5 Tier Magazines

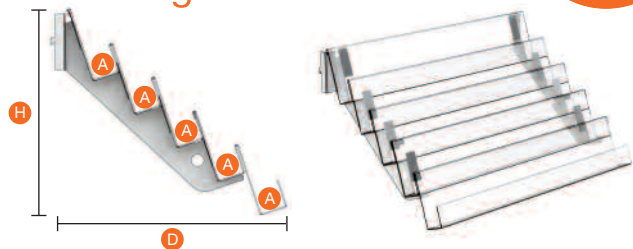

### 7 Tier Magazines

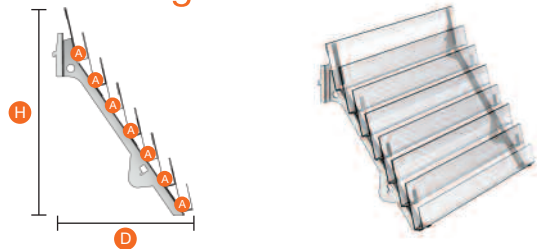

### 8 Tier Magazines

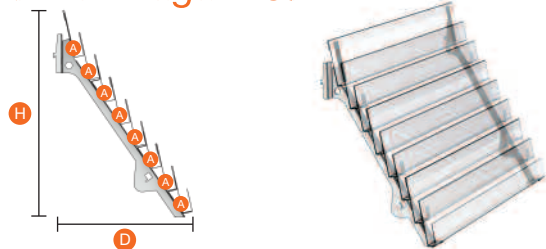

Shelf Depth

Shelf Dimensions

Shelf Widths

H Height D Depth

Shelf Depth	Shelf Dimensions	Shelf Widths						
	H Height D Depth	600mm	650mm	900mm	1000mm	1200mm	1250mm	1330mm
A 65mm (with 4 tier bracket for base shelf)	540mm 600mm	A011037	A071516	A021047	A031077	A041037	A051038	A061039
		A011265	A072254	A021249	A031923	A041336	A051330	A061188
		A011279	A072264	A021267	A031489	A041342	A051339	A061204
		£124.90	£133.40	£155.85	£155.85	£173.40	£177.65	£184.85
A 35mm	690mm 450mm	A011055	A071497	A021045	A031075	A041049	A051035	A061037
		£111.60	£116.50	£129.95	£129.95	£139.50	£141.95	£145.50
A 35mm	770mm 500mm	A011056	A071498	A021046	A031076	A041050	A051037	A061038
		£117.50	£122.50	£138.40	£138.40	£148.95	£151.50	£155.75

Bracket colour options:  Cream RAL9001  Silver RAL9006  Grey RAL9007

## Wave Bay

F3

## Magazine Shelf Dividers

- Maintain excellent product presentation using this simple hook on magazine divider

16 Tier Display  
64 Facings (1000mm bay width)  
720 mm Profile volume



- Wall display with maximum range
- Ideal for specialist titles
- Petg construction
- Wave bay is designed to fit onto a metal backing system, not freestanding
- 38mm pocket depth

H: 1900mm  
W: 1000mm  
D: 460mm

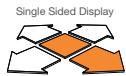

Product	Bay Widths		
	1000mm	1200mm	1250mm
Single	A001066	A041285	A051354
	£1034.50	£1136.15	£1178.05
Start Bay	A001073	A041289	A051355
	£1034.50	£1136.15	£1178.05
Middle Bay	A001074	A041290	A051356
	£896.95	£1010.60	£1052.45
End Bay	A001075	A041291	A051357
	£885.00	£998.65	£1040.45



65mm  
A101755  
£0.50

100mm  
A101731  
£0.50

### Divider Quantity Required Per Bay

Bay Widths	600mm	650mm	900mm	1000mm	1200mm	1250mm	1330mm
Dividers Per Shelf	3	3	5	5	6	6	6
8 Tier Super	24/0	24/0	40/0	40/0	48/0	48/0	48/0
8 Tier Super Plus	18/6	18/6	30/10	30/10	36/12	36/12	36/12
9 Tier Super	27/0	27/0	45/0	45/0	54/0	54/0	54/0
9 Tier Super Plus	21/6	21/6	35/10	35/10	42/12	42/12	42/12
10 Tier Super Plus	24/6	24/6	40/10	40/10	48/12	48/12	48/12
10 Tier High Volume	9/21	9/21	15/35	15/35	18/42	18/42	18/42
11 Tier Super Plus	24/9	24/9	40/15	40/15	48/18	48/18	48/18
11 Tier High Volume	18/15	18/15	30/25	30/25	36/30	36/30	36/30
6 Tier Super Low Level	18/0	18/0	30/0	30/0	36/0	36/0	36/0
6 Tier Super Gondola	18/0	18/0	30/0	30/0	36/0	36/0	36/0
7 Tier Super Low Level	21/0	21/0	35/0	35/0	42/0	42/0	42/0
7 Tier Super Gondola	21/0	21/0	35/0	35/0	42/0	42/0	42/0

## Multi Title Shelf Converter (Shelf Splitter)

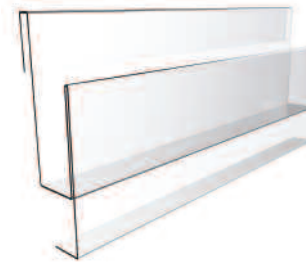

- Convert your existing shelving to display more range
- Designed to fit either 65mm or 100mm deep shelving at any width
- Creates an equal split of the existing shelf depth

To Suit Shelf Depth	Shelf Widths					
	600mm	650mm	900mm	1000mm	1200mm	1250mm
65mm	A011025 £12.50	A071190 £16.25	A021024 £16.75	A031024 £16.75	A041023 £19.15	A051025 £20.60
100mm	A011297 £12.50	A072547 £16.25	A021327 £16.75	A031079 £16.75	A041316 £19.15	A051460 £20.60

Products highlighted green are available for next day despatch  
Please quote codes on all orders. Other sizes are available subject to quotation  
Backing systems not included  
Other bay / shelf widths available upon request

Prices shown are Recommended Retail Price (RRP) and subject to discount, contact sales for a quotation



## Kids Base Plinth

A032443

8 Facings  
100 mm Pocket Depth

- Bring order to your Kids Comics
- Sits on the base shelf
- Magnetic tape to prevent movement
- 70mm interchangeable POS holder



H: 425mm  
W: 1000mm\*  
D: 483mm  
Price: £349.00

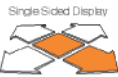

\*Other widths available upon request

## Mag Spinner

P002059

F3

40 Facing  
50 mm Pocket Depth

- Great display solution for stores with limited space
- Interchangeable header
- Fully assembled for delivery



H: 1940mm  
W: 550mm  
D: 450mm  
Price: £699.65

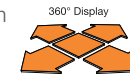

## Mag Harry

P001091

F1

12 Facing  
65 mm Pocket Depth  
780 mm Display Volume

- Ideal for product promotion or partworks
- Interchangeable header panel (graphics not included)
- Fully mobile
- Petg construction
- Black metal base
- Fully assembled



H: 1545mm  
W: 505mm  
D: 405mm  
Price: £472.40

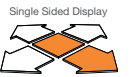

## Magazine Hook On Pocket

K001027

1 Facing  
65 mm Pocket Depth

- Highlight a retailer promotion or new product launch
  - Simply hooks onto any magazine shelf front riser
- W: 240mm (internal)  
Price: £16.70



## Essentials Magazine Pocket

K002740

1 Facing  
65 mm Pocket Depth

- The simplest hook on magazine pocket
  - Note: pocket does not have sides
- W: 240mm  
Price: £11.90



## Single Face Counter Top Magazines

N001012

1 Facing  
60 mm Pocket Depth

- Ideal for creating promotion at the till point for a single magazine title
- H: 315mm  
W: 215mm (internal)  
Price: £41.90



Products highlighted green are available for next day despatch  
Please quote codes on all orders. Other sizes are available subject to quotation

Graphics shown are not included



# Newspapers

## A Display for Everyone

The newspaper category is of utmost importance when it comes to driving footfall into your store. Quite often a primary reason for a shopper to visit, the display of newspapers must deliver highly on presentation and product availability.

### The Right Decision

With today's demands on retail space, choosing the right display for your store is paramount to the success of selling newspapers. Whether you make the decision to put newspapers on a wall bay or have them in a freestanding unit, Bartuf's choice of display solutions will guarantee to deliver success in this category.

**All hang-on shelving systems carry our unique 5 year guarantee**  
(subject to our standard conditions)



**Introducing the Flexi-News Base unit**

11	Facings (1000mm bay width)
160 /40	mm Shelf Depth
710	mm Profile volume

Bracket colour: Cream RAL9001

Width	Code	Price
800mm	B071349	£345.60
1000mm	B031287	£350.00
1200mm	B041145	£359.60
1250mm	B051150	£359.60

- Clear Petg shelf construction
- L dividers included
- Adjustable to suit depths 470mm/570mm

### Base Unit Only P1

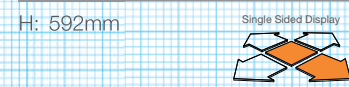

Flexi-News 1HLF Mag Wall Bag Illustrated, see page 17  
Please quote codes on all orders. Other sizes are available subject to quotation

Prices shown are Recommended Retail Price (RRP) and subject to discount, contact sales for a quotation



# Why... Bartuf Newspaper Shelving?



## 1 Shelf depth

Three shelf depths offering both high and low volume display options increasing flexibility in your wall or gondola display.

## 2 Universal fitting

The hook detail on all Bartuf brackets has been designed to fit into the majority of backing structures found in today's retail environments.

## 3 Bay widths

Whatever your bay width, Bartuf's newspaper shelving is designed to fit and make the most of the available space.

## 4 Product presentation

The newspaper shelving has been developed to display the newspapers at the optimum angle ensuring great product visibility whilst preventing newspapers from falling forwards.

## 5 Petg shelf

The inherent strength in Petg makes it a natural choice for displaying high volumes of newspapers.

## 6 Illumination

The BARliteLED™ lighting system has been designed to easily fit to any Bartuf newspaper shelf. Adding illumination not only brings a 'wow' factor to your display it is also proven to increase sales. See page 41.

## 7 Simple design

A very quick and simple system to install taking the pain out of initial set up and also future reconfigurations.

## 8 Dividers

A simple and very effective divider system that maintains a tidy display and keeps product presentation at its best.



# FLEXI-NEWS™

## The Newspaper Display for today

No matter what newspaper demand your business has, Flexi-News has a solution to suit. Founded on 22 years of news display experience coupled with the latest market insight, the features of the Flexi-News range are second to none.

### FLEXI-NEWS™ offers the following benefits:

- **Great product visibility**  
Huge 'front page' impact for your key titles, with added shelf space flexibility for higher range, lower volume display.
- **Shelf depths for today's 7 day market**  
Optimum display for mid-week and weekend news volumes.
- **Built-in display shelf flexibility**  
Unique to your store – full face, or interleaved the choice is yours to maximise those sales.
- **Space saving solutions**  
FLEXI-NEWS™ offers real space saving displays that are right for your store.
- **Simple self assembly**  
With no tools required, each display can be built in just a few minutes.
- **A quality Bartuf product you can trust**  
Easy to purchase, prompt delivery, long lasting, and great value.



From FLEXI-NEWS™ freestanding to vertical news, selecting your display has never been easier:

1. How many copies do you need to display?
2. How many facings do you require?
3. What space / location do you have in mind?

With FLEXI-NEWS™ the conclusion you reach will always be the right one for your store.

There's no better time to plan for your updated newspaper display.

Slatwall  
adaptors sold  
individually  
K201132  
£6.90 each

# FLEXI-NEWS™ Wall Bays

## Full Wall Bay

B1

## 1HLF Mag Wall Bay

P1

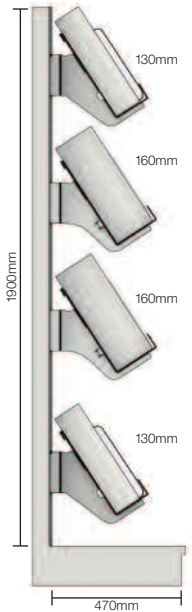

<b>12</b>	Facings (1000mm bay width)
<b>160</b>	mm Shelf Depth
<b>580</b>	mm Profile volume

- U & L dividers included
- Newspapers on base

Bracket colour: Cream RAL9001

Width	Code	Price
800mm	B071355	£392.80
1000mm	<b>B031303</b>	£392.80
1200mm	B041149	£419.65
1250mm	B051137	£453.70

Bracket colour: Silver RAL9006

Width	Code	Price
800mm	B071363	£392.80
1000mm	B031312	£392.80
1200mm	B041157	£419.65
1250mm	B051145	£453.70

Bracket colour: Grey RAL9007

Width	Code	Price
800mm	B071374	£POA
1000mm	B031321	£POA
1200mm	B041167	£POA
1250mm	B051157	£POA

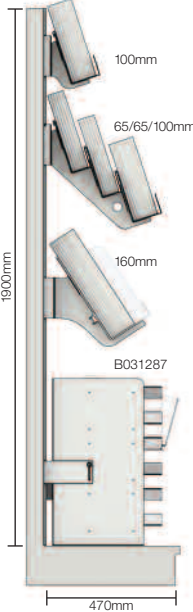

<b>11</b>	Facings (1000mm bay width)
<b>160</b>	mm Shelf Depth
<b>870</b>	mm Profile volume

- U & L dividers included
- 11 Face Base Unit

Bracket colour: Cream RAL9001

Width	Code	Price
800mm	B071357	£601.15
1000mm	B031305	£605.55
1200mm	B041151	£639.85
1250mm	B051139	£664.45

Bracket colour: Silver RAL9006

Width	Code	Price
800mm	B071366	£601.15
1000mm	B031315	£605.55
1200mm	B041160	£639.85
1250mm	B051148	£664.45

Bracket colour: Grey RAL9007

Width	Code	Price
800mm	B071373	£POA
1000mm	B031320	£POA
1200mm	B041166	£POA
1250mm	B051156	£POA

# Newspaper Shelving (including dividers)

## 130mm Shelf Depth

H: 325mm D: 360mm

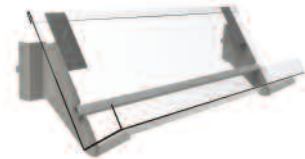

Width	Cream	Silver	Dividers	Price
800mm	B071368	B071369	1xU	£97.90
1000mm	<b>B031318</b>	B031319	1xU/1xL	£97.90
1200mm	B041169	B041165	2xU	£104.60
1250mm	B051153	B051154	2xU	£113.05
1330mm	B061093	B061094	2xU	£118.55

## 160mm Shelf Depth

H: 325mm D: 375mm



Width	Cream	Silver	Grey	Price
800mm	B071322	B071340	B071377	£98.50
1000mm	<b>B031002</b>	B031006	B031072	£98.50
1200mm	B041002	B041070	B041077	£105.25
1250mm	B051001	B051073	B051099	£113.80
1330mm	B061001	B061077	B061079	£119.25

160mm shelf divider specification is the same as the 130mm and 200mm shelf

## 200mm Shelf Depth

H: 300mm D: 475mm

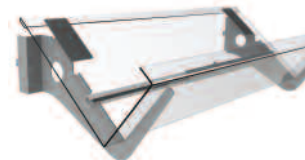

Width	Cream	Silver	Dividers	Price
800mm	B071311	B071376	1xU	£123.20
1000mm	<b>B031014</b>	B031082	1xU/1xL	£123.20
1200mm	B041012	B041093	2xU	£131.55
1250mm	B051011	B051070	2xU	£142.35
1330mm	B061009	B061078	2xU	£147.55

# Newspaper Shelf Dividers

- A simple divider system to keep product presentation at its best
- Dividers come as standard with all newspaper shelving, use the codes below if you require extra



L Divider



U Divider

Shelf Depth	Code	Price
<b>L Divider</b>		
130mm	B102510	£8.05
160/200mm	B101284	£8.55
<b>U Divider</b>		
130mm	B102509	£10.30
160mm	B101004	£10.80
200mm	B101283	£11.35

Increase sales by adding LED illumination  
(see page 41 for details)

Products highlighted green are available for next day despatch  
Please quote codes on all orders. Other sizes are available subject to quotation  
Backing systems not included  
Other bay / shelf widths available upon request



# Outside Storage Bunker

K003397



- Removable middle shelf
- X2 padlock fixings on the front (padlocks not included)
- Optional graphic header
- Adjustable feet
- Finished in Grey
- Optional graphic header (sold separately)

H: 1460mm\*  
 W: 1500mm  
 D: 840mm  
 Price: £695.00

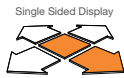

(\*with header up 1062mm when closed).

Products highlighted green are available for next day despatch  
 Please quote codes on all orders. Other sizes are available subject to quotation  
 Backing systems not included  
 Other bay / shelf widths available upon request  
 Replacement castors and lids are available upon request

Prices shown are Recommended Retail Price (RRP) and subject to discount, contact sales for a quotation

## Slimline Outside News

- Display either 9, 12 or 15 full face titles
- Integral PVC lids (weatherproof not watertight)
- Shelf depth 160mm
- Designed to fit through a standard doorway
- Durable metal construction
- Fully mobile
- Silver finish

Titles	H mm	W mm	D mm	Code	Price	
9	1370	1100	680	B001262	£695.00	P2
12	1370	1420	680	B001287	£785.00	P2
15	1370	1740	680	B001286	£945.00	P3

## 6 & 9 Facing Outside News

- Display from 6 to 9 titles
- High and low volume options
- Complete with either display zig zags or dividers
- Designed to fit through a standard doorway
- Integral PVC lids (weatherproof not watertight)
- Durable metal construction
- Fully mobile
- Silver finish
- Shelf depth 160mm

Titles	H mm	W mm	D mm	Code	Price	
6	1370	770	655	B001525	£595.00	P1
9	1370	770	655	B001528	£650.00	P1

## Low Level Outside News

- Display 10 titles in a low level outside display that does not impact on forecourt visibility
- Integral PVC lids (weatherproof not watertight)
- Designed to fit through a standard doorway
- Shelf depth 160mm

Titles	H mm	W mm	D mm	Code	Price	
10	975	1745	660	B001596	£785.00	P3

## Fixing Kit

- Anchor any Bartuf outside news unit securely to the floor to prevent theft. Includes 3x 40mm Rawlbolts

Code	Price
K001336	£40.00



**FLEXI-NEWS™**  
Single Tower

B001674

F1



4 Facing  
140<sub>/100</sub> mm Shelf Depth  
135<sub>/49</sub> Weekday/  
end Copies

- Metal base finished in black RAL9005
- Fully mobile
- Lockable castors

H: 1313mm Single Sided Display  
W: 336mm  
D: 454mm  
Price: £399.40

**FLEXI-NEWS™**  
Tall Twin Tower

B001658

F3



10<sub>/13</sub> Facing  
140<sub>/100</sub> mm Shelf Depth  
340<sub>/124</sub> Weekday/  
end Copies

- Metal base finished in black RAL9005
- Fully mobile
- Lockable castors
- Five removable dividers
- Add up to eight magazine pockets (K001001)

H: 1715mm Single Sided Display  
W: 656mm  
D: 454mm  
Price: £643.05

**FLEXI-NEWS™**  
Twin Tower

B001649

F2



8<sub>/13</sub> Facing  
140<sub>/100</sub> mm Shelf Depth  
270<sub>/98</sub> Weekday/  
end Copies

- Metal base finished in black RAL9005
- Fully mobile
- Lockable castors
- Four removable dividers
- Add up to six magazine pockets (K001001)

H: 1344mm Single Sided Display  
W: 656mm  
D: 454mm  
Price: £544.00

**FLEXI-NEWS™**  
Tall Triple Tower

B001614

F3

15<sub>/21</sub> Facing  
140<sub>/100</sub> mm Shelf Depth  
510<sub>/185</sub> Weekday/  
end Copies

- Metal base finished in black RAL9005
- Fully mobile
- Lockable castors
- Ten removable dividers
- Add up to eight magazine pockets (K001001)
- Perfect for gondola ends

H: 1715mm Single Sided Display  
W: 976mm  
D: 454mm  
Price: £812.15

**FLEXI-NEWS™**  
Triple Tower

B001648

F3



12<sub>/16</sub> Facing  
140<sub>/100</sub> mm Shelf Depth  
405<sub>/147</sub> Weekday/  
end Copies

- Metal base finished in black RAL9005
- Fully mobile
- Lockable castors
- Eight removable dividers
- Add up to six magazine pockets (K001001)
- Perfect for gondola ends

H: 1344mm Single Sided Display  
W: 976mm  
D: 454mm  
Price: £698.65

**FLEXI-NEWS™**  
Quad Tower

B001650

F4



15<sub>/21</sub> Facing  
140<sub>/100</sub> mm Shelf Depth  
510<sub>/185</sub> Weekday/  
end Copies

- Metal base finished in black RAL9005
- Fully mobile
- Lockable castors
- Eight removable dividers
- Add up to 12 magazine pockets (K001001)

H: 1385mm Double Sided Display  
W: 902mm  
D: 656mm  
Price: £1025.75

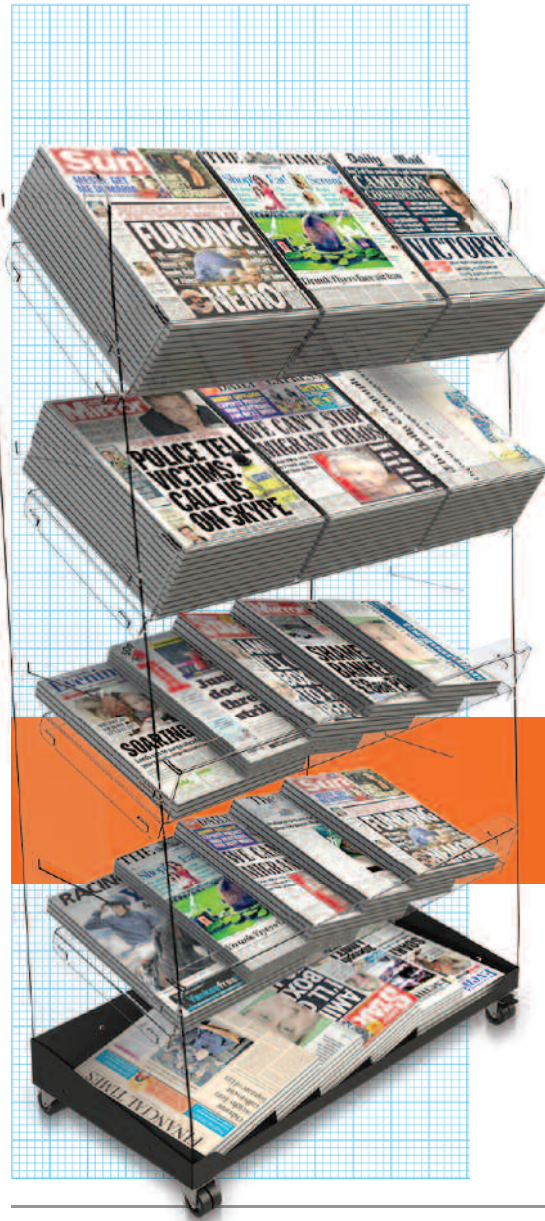

Products highlighted green are available for next day despatch  
Please quote codes on all orders. Other sizes are available subject to quotation  
Backing systems not included  
Other bay / shelf widths available upon request





**FLEXI-NEWS™** F1 B001765  
**Cross Category Single**

<b>2</b>	Facing
<b>140</b> <sub>/100</sub>	mm Shelf Depth
<b>60</b> <sub>/21</sub>	Weekday/ end Copies

- Clear body & shelving
- Metal base finished in black RAL9005
- Fully mobile
- Lockable castors
- Two removable dividers

H: 1313mm    Single Sided Display  
 W: 351mm  
 D: 454mm  
 Price: £441.70

**FLEXI-NEWS™** F3 B001733  
**Cross Category Tall Twin**

<b>8</b>	Facing
<b>140</b> <sub>/100</sub>	mm Shelf Depth
<b>213</b> <sub>/72</sub>	Weekday/ end Copies

- Clear body & shelving
- Metal base finished in black RAL9005
- Fully mobile
- Lockable castors
- Two removable dividers
- Add up to six magazine pockets (K001001)

H: 1715mm    Single Sided Display  
 W: 671mm  
 D: 462mm  
 Price: £723.85

**FLEXI-NEWS™** F2 B001731  
**Cross Category Twin**

<b>6</b>	Facing
<b>140</b> <sub>/100</sub>	mm Shelf Depth
<b>143</b> <sub>/48</sub>	Weekday/ end Copies

- Clear body & shelving
- Metal base finished in black RAL9005
- Fully mobile
- Lockable castors
- One removable divider
- Add up to five magazine pockets

H: 1344mm    Single Sided Display  
 W: 671mm  
 D: 462mm  
 Price: £627.75

**FLEXI-NEWS™** F3 B001730  
**Cross Category Tall Triple**

<b>15</b>	Facing
<b>140</b> <sub>/100</sub>	mm Shelf Depth
<b>356</b> <sub>/125</sub>	Weekday/ end Copies

- Clear body & shelving
- Metal base finished in black RAL9005
- Fully mobile
- Lockable castors
- Five removable dividers
- Add up to six magazine pockets

H: 1715mm    Single Sided Display  
 W: 991mm  
 D: 462mm  
 Price: £886.70

**FLEXI-NEWS™** F3 B001727  
**Cross Category Triple**

<b>12</b>	Facings
<b>140</b> <sub>/100</sub>	mm Shelf Depth
<b>251</b> <sub>/85</sub>	Weekday/ end Copies

- Clear body & shelving
- Metal base finished in black RAL9005
- Lockable castors
- Three removable dividers
- Add up to four magazine pockets

H: 1344mm    Single Sided Display  
 W: 991mm  
 D: 462mm  
 Price: £776.50

**FLEXI-NEWS™** F4 B001728  
**Cross Category Quad**

<b>12</b>	Facing
<b>140</b> <sub>/100</sub>	mm Shelf Depth
<b>286</b> <sub>/96</sub>	Weekday/ end Copies

- Clear body & shelving
- Metal base finished in black RAL9005
- Fully mobile
- Lockable castors
- Two removable dividers
- Add up to ten magazine pockets (K001001)

H: 1344mm    Double Sided Display  
 W: 902mm  
 D: 671mm  
 Price: £1195.00

Products highlighted green are available for next day despatch  
 Please quote codes on all orders. Other sizes are available subject to quotation  
 Graphics shown are not included

Prices shown are Recommended Retail Price (RRP) and subject to discount, contact sales for a quotation



## Tall Triple Tower

B001055

F3

15 Facing  
160 mm Shelf Depth  
630 /230 Weekday/  
end Copies

- Ideal gondola end newspaper display
- Petg construction
- Add up to 8 magazine pockets, see K001001
- Fully mobile
- Walnut effect timber base



H: 1725mm  
W: 1095mm  
D: 460mm  
Price: £950.80

Single Sided Display

## Triple Tower

B001003

F3

12 Facing  
160 mm Shelf Depth  
510 /185 Weekday/  
end Copies

- Compact display for the national titles
- Petg construction
- Add up to 6 magazine pockets, see K001001
- Fully mobile
- Walnut effect timber base



H: 1385mm  
W: 1095mm  
D: 460mm  
Price: £849.35

Single Sided Display

## Compact Cube

B001007

F4

16 Facing  
160 mm Shelf Depth  
680 /247 Weekday/  
end Copies

- Tabloid newspaper display
- Petg construction
- Add up to 12 magazine pockets, see K001001 (page 21)
- Fully mobile
- Walnut effect timber base



H: 1385mm  
W: 810mm  
D: 810mm  
Price: £1116.55

360° Display

## News Tree

B001057

S P1

12 Facing  
120 mm Shelf Depth  
360 /130 Weekday/  
end Copies

- Dedicated tabloid and broadsheet shelves
- Fully mobile
- Silver finish



H: 1300mm  
W: 630mm  
D: 800mm  
Price: £810.00

360° Display

## Dual Angle Newspaper Cube

B001289

S P2

16 Facing  
260 mm Shelf Depth  
1060 /388 Weekday/  
end Copies

- High volume newspaper display
- Shelves display flat or angled
- Fully mobile
- Silver finish



H: 1435mm  
W: 775mm  
D: 775mm  
Price: £1115.00

360° Display

## News Tree 8 Shelf + Spring Bins

B001200

S P1

12 Facing  
120 mm Shelf Depth  
840 /305 Weekday/  
end Copies

- 8 high volume display shelves
- 4 bulk newspaper spring loaded bins
- 8 promotional magazine pockets
- Fully mobile
- Silver finish



H: 1750mm  
W: 960mm  
D: 960mm  
Price: £2435.00

360° Display

## Barcube

B001006

F4

16 Facing  
160 mm Shelf Depth  
680 /247 Weekday/  
end Copies

- Dedicated tabloid and broadsheet shelves
- Petg construction
- Add up to 12 magazine pockets, see K001001 (page 21)
- Fully mobile
- Walnut effect timber base



H: 1385mm  
W: 870mm  
D: 730mm  
Price: £1131.10

360° Display

Products highlighted green are available for next day despatch  
Please quote codes on all orders. Other sizes are available subject to quotation  
\*internal



## Tall Twin Tower

**B001212**

F3



10	Facing
160	mm Shelf Depth
420	Weekday/ end Copies

- Petg construction
- Add up to 8 magazine pockets, see K001001
- Fully mobile
- Walnut effect timber base

H: 1700mm	Single Sided Display
W: 735mm	
D: 455mm	
Price: £723.55	

## Single Tower

B001001

F1



4	Facing
160	mm Shelf Depth
170	Weekday/ end Copies

- Promotional / additional weekend newspaper display
- Petg construction
- Add up to 6 magazine pockets, see K001001
- Fully mobile
- Walnut effect timber base

H: 1385mm	Single Sided Display
W: 390mm	
D: 455mm	
Price: £441.05	

## Combination Triple Tower

B001333

F4

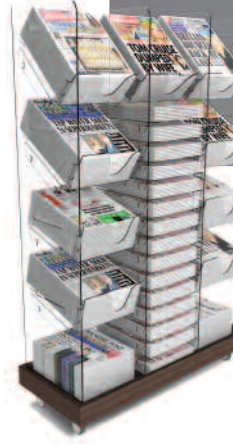

26	Facing
160	mm Shelf Depth
590	Weekday/ end Copies

- Display high and low volume
- Petg construction
- Add up to 8 magazine pockets, see K001001 (page 21)
- Fully mobile
- Walnut effect timber base

H: 1730mm	Single Sided Display
W: 1095mm	
D: 460mm	
Price: £1106.25	

## Corner Tower

B001004

F1



15	Facing
60	mm Shelf Depth
225	Weekday/ end Copies

- Ideal for local or weekly newspapers
- Very small footprint
- Petg construction
- Walnut effect timber base

H: 1245mm	Double Sided Display
W: 405mm	
D: 405mm	
Price: £592.00	

## Twin Tower

**B001002**

F2



8	Facing
160	mm Shelf Depth
340	Weekday/ end Copies

- Small footprint
- Petg construction
- Add up to 6 magazine pockets, see K001001
- Fully mobile
- Walnut effect timber base

H: 1385mm	Single Sided Display
W: 735mm	
D: 455mm	
Price: £644.65	

## Cube / Tower Magazine Pocket

**K001001**



1	Facing
45	mm Shelf Depth

- Increase promotional revenue
- Fits most Bartov news cubes and towers
- Petg

H: 215mm	Single Sided Display
W: 250mm	
D: 45mm*	
Price: £11.95	

## Multi Volume Tower

B001035

F1



12	Facing
150	mm Shelf Depth
250	Weekday/ end Copies

- High and low volume
- Small footprint
- Petg construction
- Fully mobile
- Walnut effect timber

H: 1575mm	Single Sided Display
W: 470mm	
D: 460mm	
Price: £747.50	

## Multi Title Tower

B001005

P1



17	Facing
120	mm Shelf Depth
230	Weekday/ end Copies

- Ideal for international or local newspapers
- Low volume/high range
- Petg construction
- Walnut effect timber base
- Interchangeable POS header (graphic not included)

H: 1870mm	Single Sided Display
W: 460mm	
D: 360mm	
Price: £735.55	

Products highlighted green are available for next day despatch  
Please quote codes on all orders. Other sizes are available subject to quotation  
Graphics shown are not included

# Why... Bartuf Confectionery Shelving?



## 1 Dual angle display shelving

Display your confectionery products on either a flat or angled shelving system all with one shelf using the Bartuf unique hook in system.

## 2 Extensive range of sizes

From 150mm to 450mm deep shelving and any width from 600mm to 1250mm making it easy for you to tailor your confectionery display to your exact requirements.

## 3 All shelves include SEL's

One thing less to think about when ordering your confectionery display, all shelves come supplied with a 39mm SEL as standard.

## 4 Petg shelf material

Selected for its excellent clarity and strength.

## 5 Universal fitting

The hook detail on all Bartuf brackets has been designed to fit into the majority of backing structures found in today's retail environments.

## 6 Illumination

The BARliteLED™ lighting system has been designed to easily fit any Bartuf confectionery shelf. Adding illumination not only brings a 'wow' factor to your display it is also proven to increase sales. See page 41.

### Dual Angle Shelving

Display the Flangle™ shelf in either a flat or angled position.

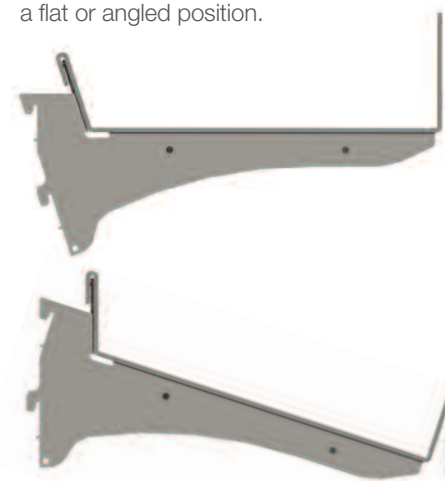

Please quote codes on all orders. Other sizes are available subject to quotation

## Confectionery Bays

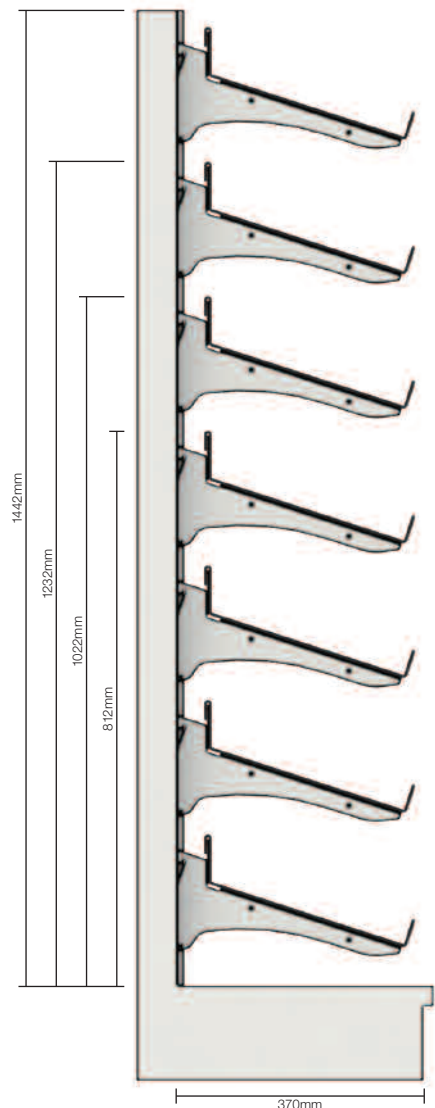

### Bay Profile

### Bay Dimensions

Ⓜ Height      Ⓜ Depth

	600mm	650mm	900mm	1000mm	1200mm	1250mm		
4 Tier Confectionery Bay	812mm	370mm	D011205	D071492	D021133	D031505	D041203	D051138
			D011214	D071721	D021145	D031761	D041255	D051191
			£304.25	£364.50	£364.50	£364.50	£395.15	£437.00
5 Tier Confectionery Bay	1022mm	370mm	D011206	D071491	D021134	D031504	D041202	D051137
			D011215	D071722	D021146	D031762	D041256	D051192
			£380.30	£455.70	£455.70	£455.70	£493.95	£546.25
6 Tier Confectionery Bay	1232mm	370mm	D011207	D071490	D021135	D031503	D041201	D051136
			D011216	D071723	D021147	D031763	D041257	D051193
			£456.35	£546.80	£546.80	£546.80	£592.70	£655.50
7 Tier Confectionery Bay	1442mm	370mm	D011208	D071489	D021136	D031502	D041200	D051135
			D011217	D071724	D021148	D031764	D041258	D051194
			£532.45	£637.90	£637.90	£637.90	£691.45	£764.75

Bracket colour options:  Cream RAL9001     Silver RAL9006

All bays using Flangle™ shelving, see page 25

**Increase sales by adding LED illumination**  
(see page 41 for details)

Backing systems shown are not included

Please quote codes on all orders. Other sizes are available subject to quotation  
Other bay / shelf widths available upon request  
Backing systems not included

Prices shown are Recommended Retail Price (RRP) and subject to discount, contact sales for a quotation



Slatwall  
adaptors sold  
individually  
K201132  
£6.90 each

# Individual Flangle™ Shelves

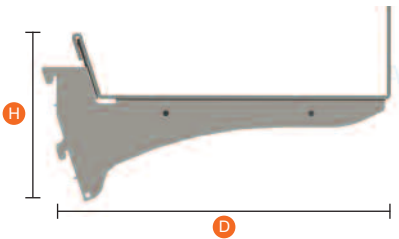
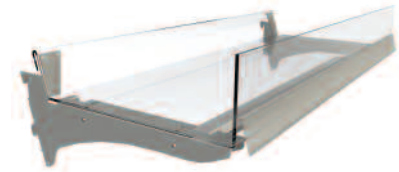

• Display flat or angled with one shelf

Shelf Depth	Shelf Dimensions		Shelf Widths					
	H Height (Flat)	D Depth	600mm	650mm	900mm	1000mm	1200mm	1250mm
150mm (to suit bay depth 200mm)	170mm	200mm	D011109	D071274	D021094	D031254	D041139	D051109
			POA	POA	POA	POA	POA	POA
			£65.05	£74.65	£74.65	£74.65	£76.80	£94.65
200mm (to suit bay depth 250mm)	170mm	250mm	D011108	D071273	D021093	D031253	D041138	D051108
			D011197	D071386	D021125	D031471	D041234	D051167
			£70.10	£82.00	£82.00	£82.00	£88.30	£104.65
250mm (to suit bay depth 300mm)	170mm	300mm	D011107	D071272	D021092	D031252	D041137	D051107
			D011198	D071385	D021126	D031470	D041198	D051168
			£72.00	£85.15	£85.15	£85.15	£92.10	£106.95
300mm (to suit bay depth 350mm)	180mm	350mm	D011106	D071271	D021091	D031251	D041136	D051106
			D011126	D071416	D021127	D031316	D041157	D051143
			D011195	D071424	D021129	D031430	D041235	D051169
			£76.05	£91.10	£91.10	£91.10	£98.80	£109.25
350mm (to suit bay depth 400mm)	180mm	400mm	D011105	D071270	D021090	D031250	D041135	D051105
			D011125	D071415	D021108	D031390	D041156	D051144
			D011196	D071423	D021130	D031429	D041236	D051170
			£77.45	£92.65	£92.65	£92.65	£100.45	£115.15
400mm (to suit bay depth 450mm)	210mm	450mm	D011104	D071269	D021089	D031249	D041134	D051104
			D011124	D071608	D021121	D031322	D041155	D051145
			D011194	D071421	D021131	D031428	D041237	D051171
			£81.30	£98.80	£98.80	£98.80	£107.35	£119.25
450mm (to suit bay depth 500mm)	215mm	500mm	D011103	D071268	D021088	D031248	D041133	D051103
			D011123	D071505	D021128	D031297	D041154	D051146
			D011200	D071420	D021132	D031427	D041238	D051172
			£92.10	£110.65	£110.65	£110.65	£120.35	£145.00

Bracket colour options: Cream RAL9001 Silver RAL9006 Grey RAL9007

Increase sales by adding LED illumination  
(see page 41 for details)

Products highlighted green are available for next day despatch  
Please quote codes on all orders. Other sizes are available subject to quotation  
Backing systems not included  
Other bay / shelf widths available upon request



## Wrapped Sweets Bay

D031463

F2

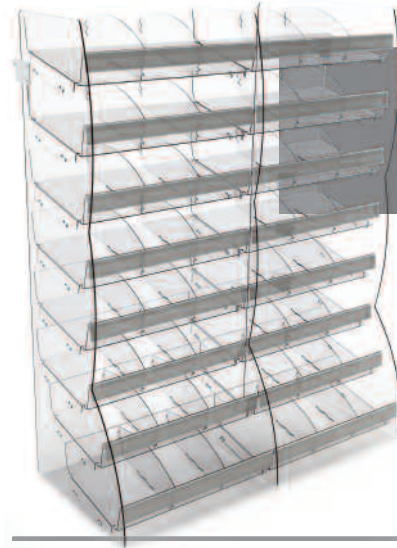

48 Facings  
(1000mm bay width)  
245 mm Shelf Depth

- Ideal for displaying kids loose confectionery
- 39mm SEL included
- Petg construction
- Fits any 1m metal backing wall bay

H: 1250mm  
W: 1000mm  
D: 450mm  
Price: £535.80



## Hook on Confectionery Pocket

K001081



65 mm Pocket Depth

- Hook on to any shelf riser
- Promotional impulse purchase
- Petg construction

H: 80mm  
W: 375mm\*  
D: 65mm\*  
Price: £29.85

## Counter Front Confectionery

P001009

B1



5 Shelves  
175 mm Shelf Depth

- Create impulse purchases at the till
- Single sided display
- 39mm SEL included
- Petg construction
- Walnut effect timber base

H: 900mm  
W: 505mm  
D: 290mm  
Price: £460.45

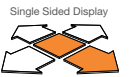

## Mini Counter Display

N071006

B1



4 Shelves  
140 mm Shelf Depth

- Promotional counter top display
- Very small footprint
- 39mm SEL included
- Petg construction

H: 400mm  
W: 330mm\*  
D: 250mm  
Price: £117.20

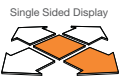

Please quote codes on all orders. Other sizes are available subject to quotation

\*internal



# Why... Bartuf Snack Shelving?



## 1 Unique design

Using the same bracket system as the confectionery shelving, the snack shelving incorporates a dedicated shelf which not only allows you to quickly bulk merchandise the display but also has an integral front display riser to hold a single pack of crisps to maintain a tidy display.

## 2 Petg shelf material

Selected for its excellent clarity and strength.

## 3 Extensive range of sizes

From 300mm to 450mm deep shelving and any width from 600mm to 1250mm making it easy for you to tailor your snacking display to your exact requirements.

## 4 All shelves include SEL's

One thing less to think about when ordering your snack display, all shelves come supplied with a 39mm SEL as standard.

## 5 Universal fitting

The hook detail on all Bartuf brackets has been designed to fit into the majority of backing structures found in today's retail environments.

## 6 In store trials

Proven to increase sales by over 20% when compared to wire baskets.

### Snacking bin options

If you need ultimate flexibility in your display then using a snacking bin may be the best option, with many width and depth options, your snack display can be configured exactly to your requirements.



Please quote codes on all orders. Other sizes are available subject to quotation

## Adjustable Snack Bays

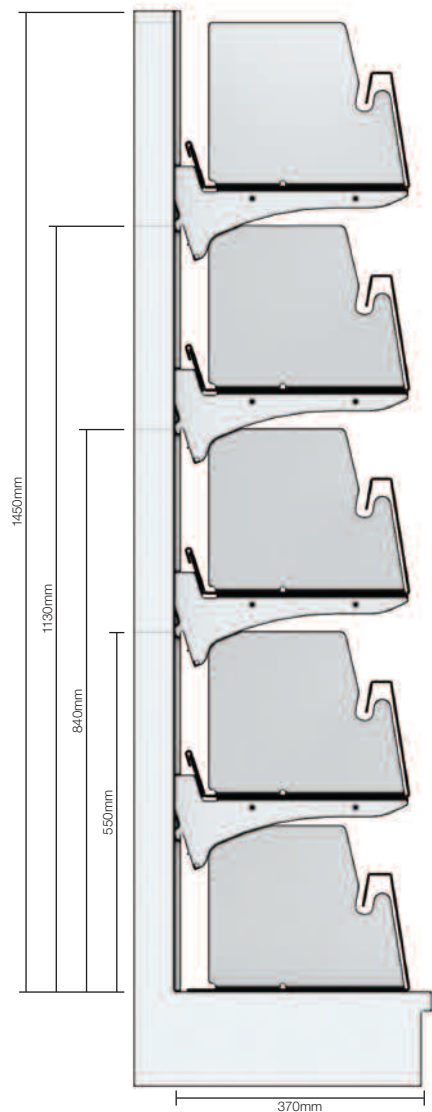

Bay Profile	Bay Dimensions		Bay Widths					
	H Height	D Depth	600mm	650mm	900mm	1000mm	1200mm	1250mm
2 Tier Snacks	550mm	370mm	E011099 £182.55	E071204 £192.70	E021091 £243.75	E031267 £260.65	E041118 £309.05	E051091 £314.90
3 Tier Snacks	840mm	370mm	E011100 £286.15	E071203 £303.30	E021092 £377.25	E031266 £402.40	E041117 £474.20	E051090 £484.85
4 Tier Snacks	1130mm	370mm	E011101 £389.70	E071202 £413.95	E021093 £510.75	E031265 £544.10	E041116 £639.35	E051089 £654.75
5 Tier Snacks	1450mm	370mm	E011102 £493.30	E071201 £524.60	E021094 £644.25	E031264 £685.85	E041115 £804.50	E051088 £824.70

All shelves include dividers

Please quote codes on all orders. Other sizes are available subject to quotation  
 Backing systems shown are not included  
 Other bay / shelf widths available upon request

Prices shown are Recommended Retail Price (RRP) and subject to discount, contact sales for a quotation



Slatwall  
adaptors sold  
individually  
K201132  
£6.90 each

## Adjustable Snack Shelves

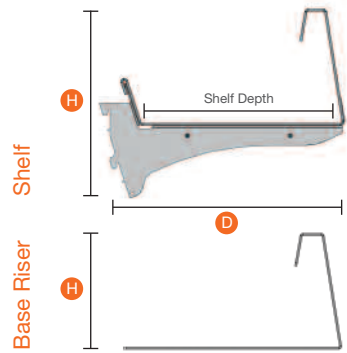

◦ Promotional front to maintain excellent product visibility

Shelf Depth	Shelf Dimensions		Shelf Widths					
	H Height	D Depth	600mm	650mm	900mm	1000mm	1200mm	1250mm
300mm (to suit 350mm)	300mm	350mm	E011082	E071142	E021073	E031161	E041087	E051080
			E011090	E071262	E021078	E031284	E041132	E051109
			E011094	E071267	E021085	E031237	E041134	E051114
			£82.00	£89.05	£105.25	£106.80	£123.55	£128.35
350mm (to suit 400mm)	300mm	400mm	E011083	E071143	E021074	E031162	E041088	E051081
			E011091	E071263	E021081	E031319	E041092	E051113
			E011089	E071185	E021086	E031236	E041131	E051115
			£83.25	£91.80	£106.80	£108.15	£123.95	£129.70
400mm (to suit 450mm)	300mm	450mm	E011084	E071144	E021075	E031163	E041089	E051082
			E011092	E071264	E021082	E031203	E041093	E051086
			E011095	E071268	E021087	E031235	E041135	E051116
			£86.10	£94.65	£111.65	£113.15	£130.10	£135.40
450mm (to suit 500mm)	300mm	500mm	E011085	E071145	E021076	E031164	E041090	E051083
			E011093	E071265	E021083	E031215	E041094	E051112
			E011096	E071172	E021088	E031216	E041102	E051117
			£91.50	£98.80	£125.10	£126.75	£138.55	£143.50
Base Riser	175mm	330mm	E011023	E071048	E021019	E031035	E041024	E051017
			£57.40	£60.45	£82.00	£84.00	£102.30	£103.35

Bracket colour options:  Cream RAL9001  Silver RAL9006  Grey RAL9007

## Dividers



	Divider Size (to suit shelf depth)					
	300mm	350mm	400mm	450mm	500mm (for base riser)	550mm (for base riser)
Central Divider	E101019 £6.70	E101020 £6.70	E101021 £8.55	E101022 £8.55	E101028 £8.55	E101047 £9.40
End Divider (pair)	E101023 £14.90	E101024 £14.90	E101025 £18.95	E101026 £18.95	E101027 £18.95	E101048 £20.10

Please quote codes on all orders. Other sizes are available subject to quotation  
Other bay / shelf widths available upon request

## Promotional Front Individual Snack Bins

B1



- Create wall and gondola bays
- Simple to stack
- Integral front single pack holder
- Petg construction
- Dividers included

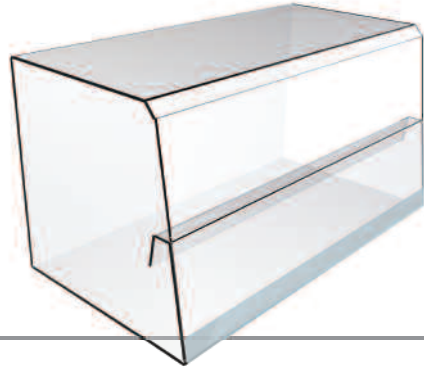

**Number of Dividers Included**

Bin Width	Dividers
900mm	2
1000mm	2
1250mm	3

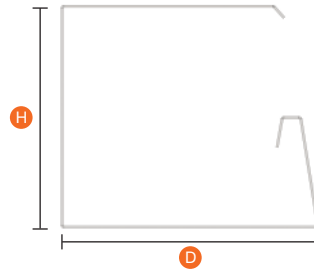

Shelf Depth	Shelf Dimensions		Shelf Widths		
	H Height	D Depth	900mm	1000mm	1250mm
300mm	345mm	300mm	E021008 £123.55	E031024 £123.55	E051008 £132.50
350mm	345mm	350mm	E021009 £135.40	E031025 £135.40	E051009 £144.45
400mm	345mm	400mm	E021010 £149.00	E031026 £149.00	E051010 £155.45
450mm	345mm	450mm	E021011 £158.60	E031027 £158.60	E051011 £173.45
500mm	345mm	500mm	E021012 £172.45	E031028 £172.20	E051012 £191.35

## Individual Snacking Bins

B1



- Create wall and gondola bays
- Simple to stack
- Low profile bin for more range
- Petg construction
- Dividers included



**Number of Dividers Included**

Bin Width	Dividers
900mm	2
1000mm	2
1250mm	3

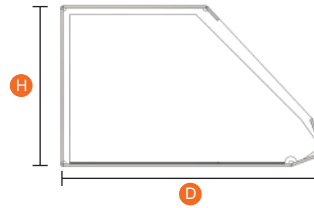

Shelf Depth	Shelf Dimensions		Shelf Widths		
	H Height	D Depth	900mm	1000mm	1250mm
300mm	245mm	300mm	E021003 £93.30	E031001 £93.30	E051004 £106.95
350mm	245mm	350mm	E021004 £110.95	E031002 £110.95	E051003 £125.25
400mm	245mm	400mm	E021001 £113.15	E031003 £113.15	E051001 £127.70
450mm	245mm	450mm	E021005 £118.60	E031004 £118.60	E051002 £136.15
500mm	245mm	500mm	E021006 £122.80	E031005 £122.80	E051005 £144.45

Please quote codes on all orders. Other sizes are available subject to quotation  
 Backing systems shown are not included  
 Other bay / shelf widths available upon request



Slatwall adaptors sold individually K201132 £6.90 each

# Snack Bay

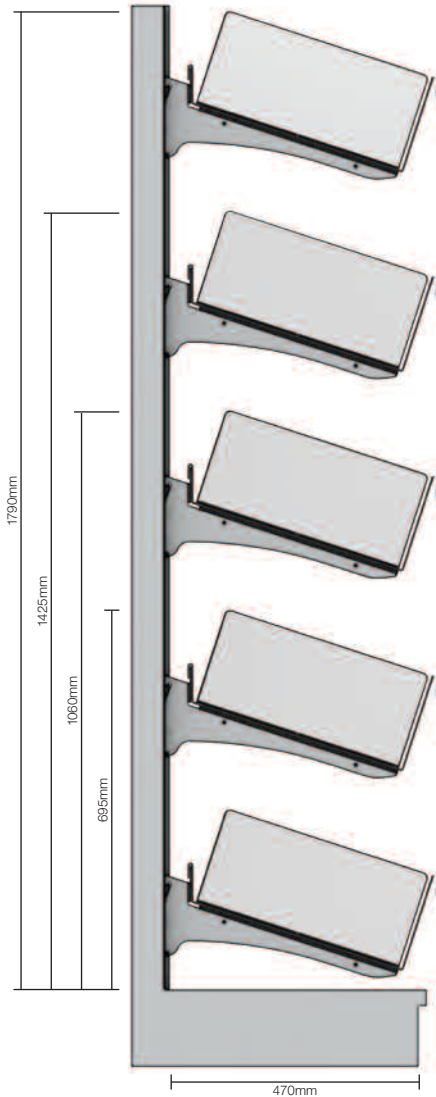

- Bulk crisps display
- Flat or angle shelf position
- Includes 2 dividers and 2 end dividers per shelf
- 39mm SEL to all shelves

Bay Depth	Bay Dimensions		Bay Widths					
	H Height	D Depth	600mm	650mm	900mm	1000mm	1200mm	1250mm
5 Tier Snack Bay with High Risers	1790mm	470mm	E011108	E071247	E021101	E031308	E041153	E051105
			E011110	E071316	E021103	E031385	E041155	E051141
			E011112	E071308	E021105	E031378	E041157	E051137
			£394.65	£394.65	£412.65	£412.65	£556.15	£574.05

Bay Depth	Bay Dimensions		Bay Widths					
	H Height	D Depth	600mm	650mm	900mm	1000mm	1200mm	1250mm
400mm with High Riser	210mm	400mm	E011109	E071246	E021102	E031309	E041144	E051104
			E011111	E071303	E021104	E031371	E041156	E051131
			E011113	E071317	E021106	E031386	E041158	E051142
			£78.95	£78.95	£82.55	£82.55	£111.25	£114.80

Bracket colour options: ● Cream RAL9001 ● Silver RAL9006 ● Grey RAL9007

## Single Snacks Wall Bay

F2

9	Shelves	
440	mm Shelf Depth	
H: 1710mm		
W: See table		
D: 470mm		
Width	Code	Price
650mm	E071257	£657.75
1000mm	E031324	£759.45
1250mm	E051110	£873.05

## Single Snacks Gondola Bay

F2

7	Selves	
440	mm Shelf Depth	
H: 1300mm		
W: See table		
D: 470mm		
Width	Code	Price
650mm	E071230	£514.25
1000mm	E031305	£592.00
1250mm	E051108	£681.70

Products highlighted green are available for next day despatch  
Please quote codes on all orders. Other sizes are available subject to quotation  
Backing systems shown are not included  
Other bay / shelf widths available upon request

# Greetings Cards

Ultimate flexibility in display options with Bartuf's greeting card shelving.

An all-in-one bracket and shelf combinations offer maximum visual impact in any store.

From 2 tiers to 25 tiers all in one bay!

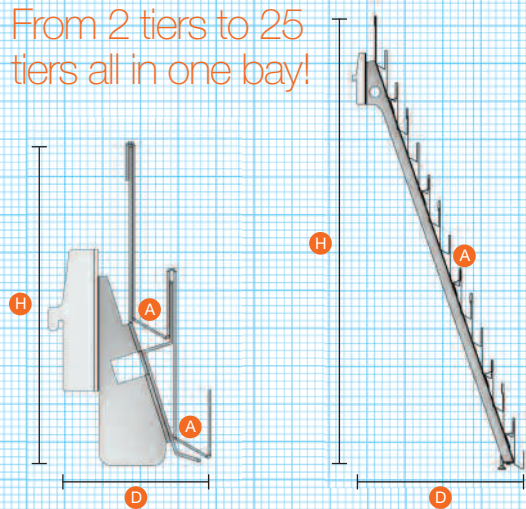

Slatwall adaptors sold individually K201132 £6.90 each

## Greetings Card Shelving

Shelf	Pocket Depth	Shelf Dimensions		Shelf Widths						
		H Height	D Depth	600mm	650mm	900mm	1000mm	1200mm	1250mm	1330mm
2 Tier	A 30mm	260mm	115mm	C011020	C071103	C021007	C031012	C041010	C051008	C061008
				£61.50	£66.15	£66.15	£66.15	£69.20	£71.80	£78.30
3 Tier	A 30mm	340mm	140mm	C011001	C071022	C021003	C031001	C041001	C051003	C061003
				C011023	C071408	C021090	C031011	C041009	C051090	C061082
				C011114	C071177	C021094	C031100	C041082	C051102	C061088
				£64.55	£69.65	£69.65	£69.65	£72.65	£75.65	£82.50
6 Tier	A 30mm	620mm	235mm	C011002	C071031	C021004	C031002	C041002	C051004	C061004
				C011110	C071428	C021087	C031107	C041120	C051079	C061083
				C011114	C071177	C021094	C031100	C041082	C051102	C061088
				£125.55	£136.85	£136.85	£136.85	£142.40	£148.65	£162.00
8 Tier	A 30mm	800mm	300mm	C011003	C071040	C021005	C031003	C041003	C051005	C061005
				C011111	C071429	C021083	C031028	C041092	C051080	C061084
				C011114	C071177	C021094	C031100	C041082	C051102	C061088
				£148.65	£164.05	£164.05	£164.05	£172.10	£176.45	£195.35
11 Tier	A 30mm	1080mm	395mm	C011005	C071004	C021001	C031005	C041005	C051001	C061001
				C011111	C071429	C021083	C031028	C041092	C051080	C061084
				£172.45	£193.75	£193.75	£193.75	£205.05	£212.80	£238.80
12 Tier	A 30mm	1170mm	425mm	C011004	C071013	C021002	C031004	C041004	C051002	C061002
				C011025	C071430	C021091	C031010	C041008	C051092	C061085
				C011114	C071177	C021094	C031100	C041082	C051102	C061088
				£184.35	£207.30	£207.30	£207.30	£218.65	£224.35	£251.95
14 Tier	A 28mm	1180mm	465mm	C011009	C071101	C021013	C031006	C041006	C051006	C061009
				C011111	C071429	C021083	C031028	C041092	C051080	C061084
				£199.40	£224.35	£224.35	£224.35	£236.35	£242.85	£271.85

Bracket colour options:  Cream RAL9001  Silver RAL9006  Grey RAL9007

Products highlighted green are available for next day despatch  
 Please quote codes on all orders. Other sizes are available subject to quotation  
 Backing systems shown are not included  
 Other bay / shelf widths available upon request

Prices shown are Recommended Retail Price (RRP) and subject to discount, contact sales for a quotation



### 15 Tier Greeting Card Bay

B1

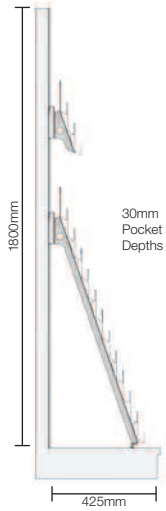

15	Tier Display
90	Facings (Based on A5 cards & 1000mm width)
450	mm Profile volume

Bracket colour: Cream RAL9001

Width	Cream	Silver	Price
600mm	C011029	C011112	£236.65
650mm	C071088	C071340	£263.45
900mm	C021011	C021092	£263.45
1000mm	C031022	C031027	£263.45
1200mm	C041016	C041102	£277.00
1250mm	C051012	C051068	£309.80
1330mm	C061006	C061086	£318.85

### 16 Tier Greeting Card Bay

B1

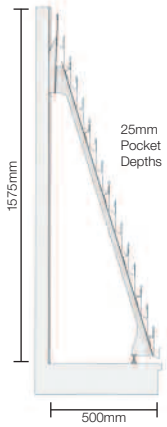

16	Tier Display
96	Facings (Based on A5 cards & 1000mm width)
400	mm Profile volume

Bracket colour: Cream RAL9001

Width	Code	Price
600mm	C011120	£228.05
650mm	C071512	£239.20
900mm	C021099	£250.30
1000mm	C031349	£250.30
1200mm	C041130	£261.45
1250mm	C051118	£267.00
1330mm	C061091	£278.15

### 21 Tier Greeting Card Bay

B1

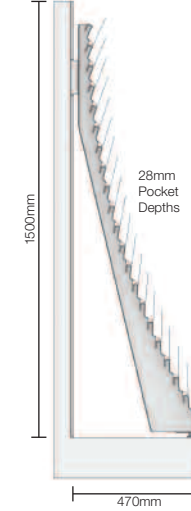

21	Tier Display
126	Facings (Based on A5 cards & 1000mm width)
588	mm Profile volume

Bracket colour: Cream RAL9001

Width	Code	Price
600mm	C011109	£346.00
650mm	C071422	£349.35
900mm	C021089	£354.50
1000mm	C031036	£354.50
1200mm	C041119	£402.75
1250mm	C051101	£404.95
1330mm	C061070	£414.95

### 17 Tier Greeting Card Bay

B1

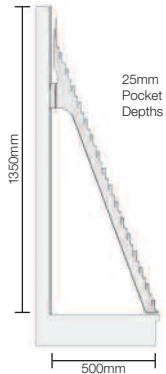

17	Tier Display
102	Facings (Based on A5 cards & 1000mm width)
425	mm Profile volume

Bracket colour: Cream RAL9001

Width	Code	Price
600mm	C011108	£282.30
650mm	C071421	£285.15
900mm	C021088	£289.25
1000mm	C031305	£289.25
1200mm	C041118	£328.90
1250mm	C051100	£330.40
1330mm	C061080	£338.65

### 25 Tier Greeting Card Bay

B1

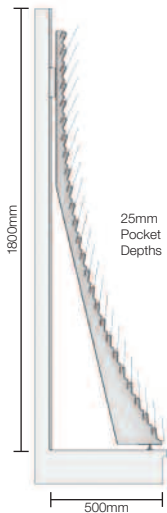

25	Tier Display
150	Facings (Based on A5 cards & 1000mm width)
625	mm Profile volume

Bracket colour: Cream RAL9001

Width	Cream	Silver	Price
600mm	C011106	C011113	£394.55
650mm	C071333	C071431	£396.95
900mm	C021084	C021093	£402.75
1000mm	C031210	C031256	£402.75
1200mm	C041099	C041121	£457.85
1250mm	C051088	C051098	£460.20
1330mm	C061072	C061087	£471.50

### Greeting Card Dividers



Pack of 20

Code	Price
C501001	£4.25

Slatwall adaptors sold individually K201132 £6.90 each

Products highlighted green are available for next day despatch  
Please quote codes on all orders. Other sizes are available subject to quotation  
Backing systems not included  
Other bay / shelf widths available upon request

## Slatwall Card Shelf

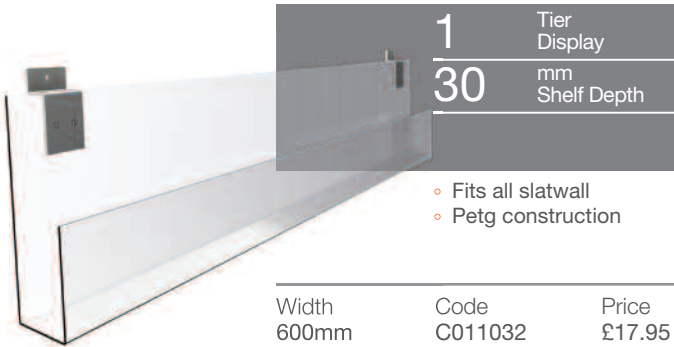

1 Tier Display  
30 mm Shelf Depth

- Fits all slatwall
- Petg construction

Width	Code	Price
600mm	C011032	£17.95
650mm	C071124	£19.40
900mm	C021014	£21.10
1000mm	C031030	£21.10
1200mm	C041021	£21.85
1250mm	C051014	£21.85

## Slatwall Confectionery Shelf



200 mm Pocket Depth  
70 mm Riser Height

- Fits into any slatwall
- Ideal low cost counter front display
- Petg construction

Width	Code	Price
440mm	D102026	£25.75

## Gift Wrap Ladder

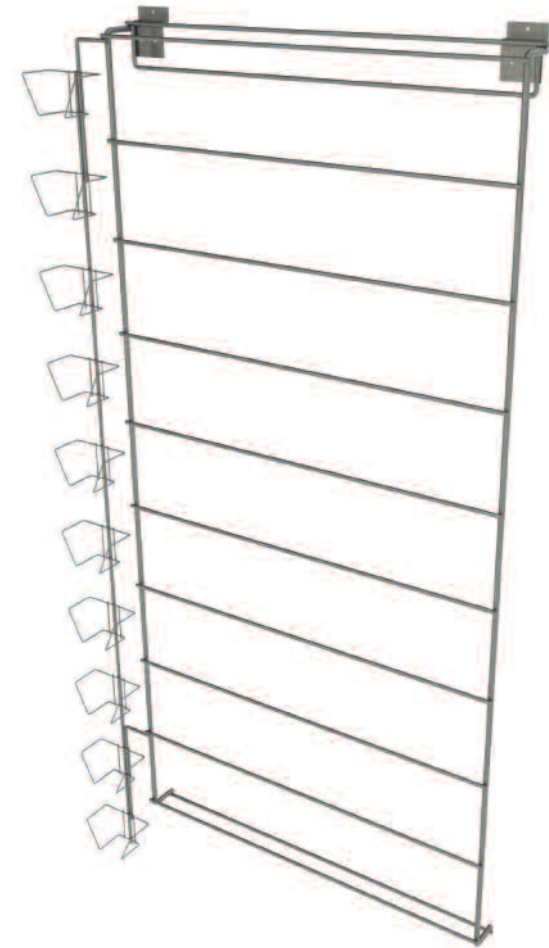

- Fits all slatwall
- Metal construction
- 10 rungs
- 10 Tag holders
- White finish

H: 1145mm  
W: 610mm  
D: 95mm  
Price: £45.85

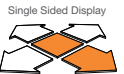

## Slatwall Flat Shelves

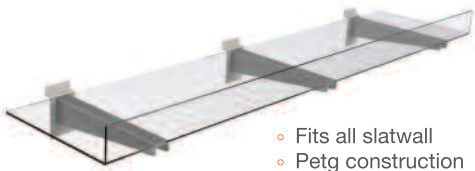

- Fits all slatwall
- Petg construction

Shelf Depth	Shelf Widths					
	600mm	650mm	900mm	1000mm	1200mm	1250mm
225mm	G011001 £37.60	G071086 £41.20	G021007 £46.65	G031002 £46.65	G041002 £50.95	G051010 £52.10
300mm	G011002 £40.60	G071087 £44.30	G021008 £49.75	G031003 £49.75	G041003 £52.75	G051011 £53.95

## Single Gift Wrap Bar



1 Facings

- Fits all slatwall
- Metal construction
- White finish

Width	Code	Price
575mm	G001011	£9.65

Products highlighted green are available for next day despatch  
Please quote codes on all orders. Other sizes are available subject to quotation



# Gondola Side Display

## Creating Display Space

Create additional selling space in your store with the Gondola Side Display. With no impact on floor space, this simple to fit display solution can bring the ends of a gondola to life whilst maximising your impulse sales opportunities.

A unique design of fitting gives the gondola side display a universal fix to most gondolas and a range of sizes allows you to get the most from your display space.

With a range of shelving displays to fit, the gondola side display is ideal for promoting impulse sales on categories such as magazines, confectionery, snacks, greeting cards and much more.

### Gondola Side Frame

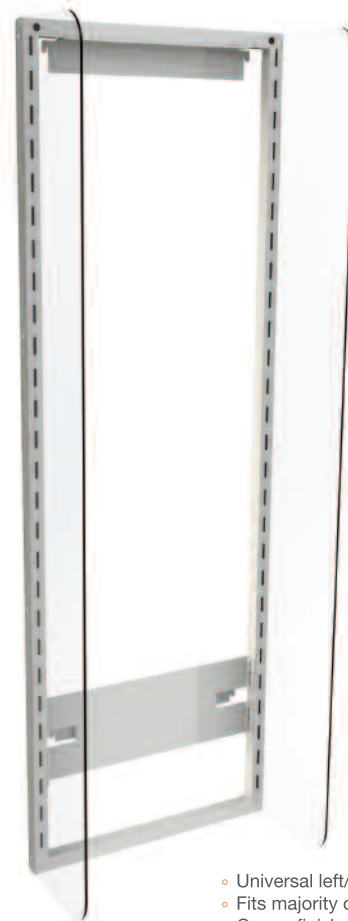

- Universal left/right hand fit
- Fits majority of backing systems
- Cream finish metal frame
- Petg side wings
- Slotted frame 50mm pitch

H:	Width	Code	Price
1400mm	470mm	K071279	£151.25
W: 220mm	570mm	K071237	£154.90

### Size Guide

Two sizes of Gondola Frame offers flexibility to fit gondola base depths of 400mm and above.

W 470mm - K071279  
(to fit gondola base depth of 400mm and above)

W 570mm - K071237  
(to fit gondola base depth of 500mm and above)

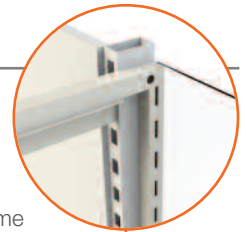

Note:  
Gondola side frame width overlaps upright of existing gondola

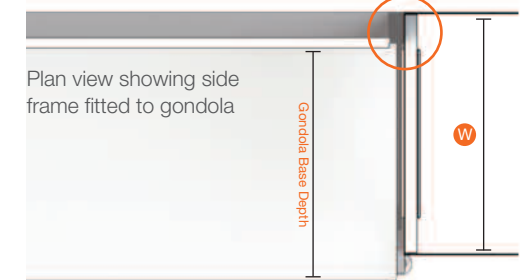

### Universal Fitting

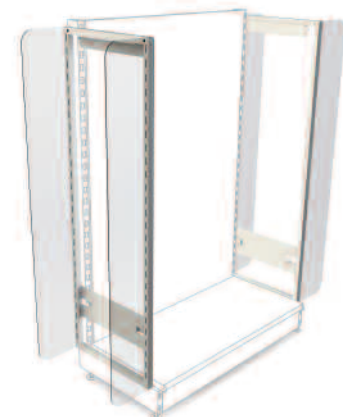

Simple to order

One bracket design fits both left and right hand side of gondola end.

Products highlighted green are available for next day despatch  
Please quote codes on all orders. Other sizes are available subject to quotation  
Backing systems not included  
Other bay / shelf widths available upon request



### Hanging Bar



• Zinc plated

Width	Code	Price
470mm	<b>K071283</b>	£22.75
570mm	<b>K071275</b>	£25.15

### Eurohook + Ticket Carrier

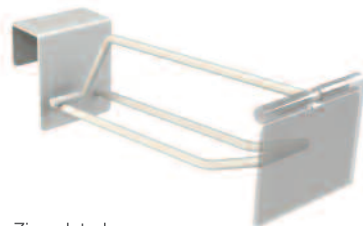

• Zinc plated

Length	Code	Price
150mm	<b>K502254</b>	£7.35

### Hanging Bar & Eurohooks



• Zinc plated

Width	Code	Price
470mm	<b>K071282</b>	£44.80
570mm	<b>K071274</b>	£47.15

### Magazine Shelf

1Tier / 65mm

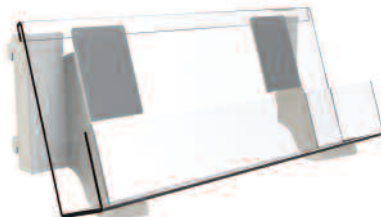

Width	Code	Price
470mm	<b>A072064</b>	£43.20
570mm	<b>A072063</b>	£44.30

### Adjustable Shelf

155mm Shelf Depth

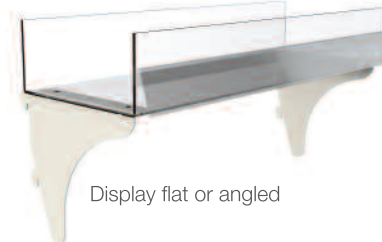

Display flat or angled

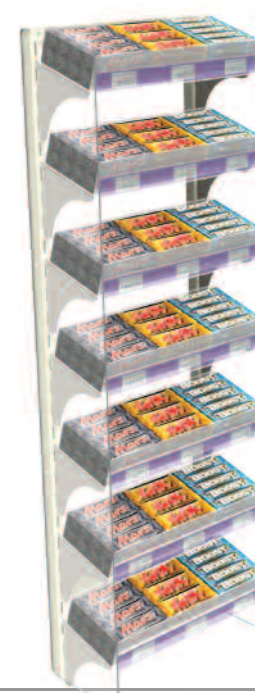

Width	Code	Price
470mm	<b>K071281</b>	£25.15
570mm	<b>K071273</b>	£25.15

### Greeting Card Shelf

3 Tier / 30mm



Width	Code	Price
470mm	<b>C071388</b>	£37.45
570mm	<b>C071387</b>	£40.45

Products highlighted green are available for next day despatch  
 Illustrations show bay examples. Codes & prices are for individual display components.  
 Please quote codes on all orders. Other sizes are available subject to quotation



# 4 Queue Management

## Increase Sales Opportunities

Introducing an in-queue display system is an excellent method of increasing sales on the average basket spend by enticing further impulse sales at the till point.



## Understanding the product mix in your queue really can help drive sales.

Short queue systems are best planned to display high impulse items only. On longer walk through configurations a large range of product can be introduced ranging from having a browsing zone through to high impulse products near to the exit point.

As a customer passes through a queue system the time to browse product diminishes the nearer they get to the exit point, this needs to be reflected in the product choice for certain zones.

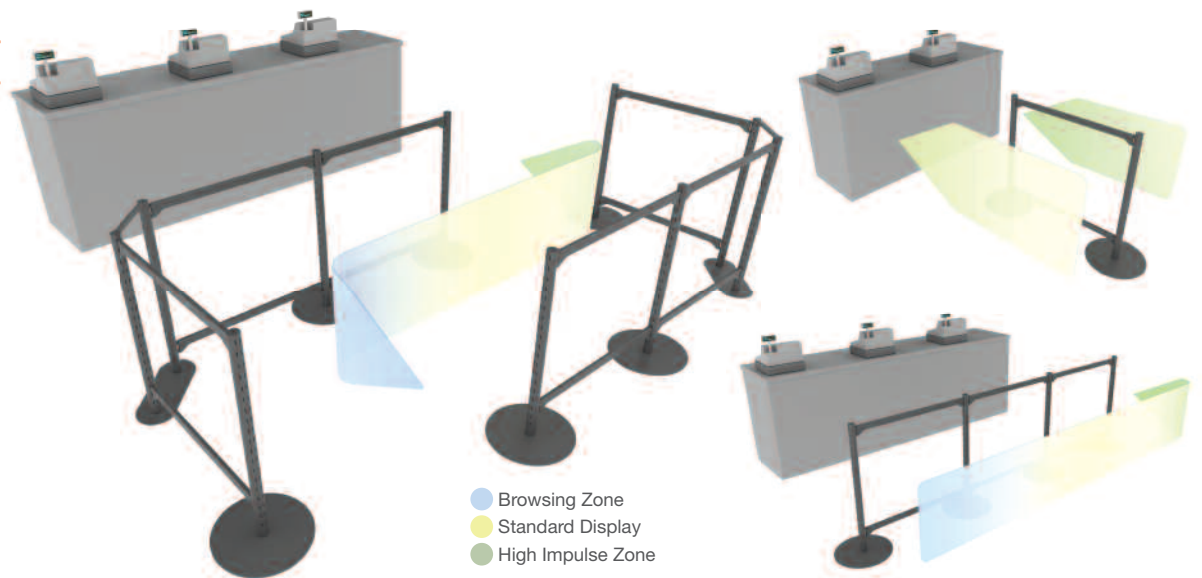

## The System

Comprising of only uprights and tie bars, the assembly of the sub structure is very simple keeping installation times to a minimum



- Robust steel construction ensuring longevity in the harshest of retail environments
- Finish: Anthracite as standard, other colours available on request

## Uprights



- 1000mm/1200mm upright height options - slotted uprights to hang display add on shelves such as confectionery and magazines
- 50mm pitch slotted uprights

Height	Code	Price
1000mm	N001448	£84.00
1200mm	N001442	£86.00

## Corner Uprights

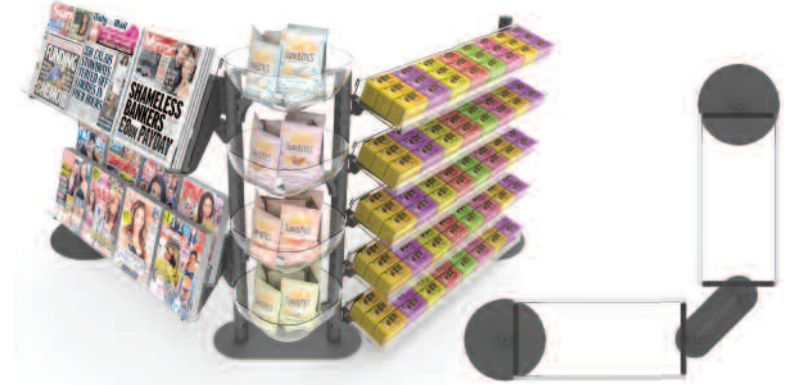
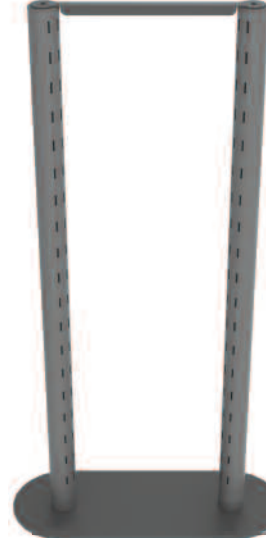

- Run any display right into the corners of your queue management system on both sides.
- 1000mm/1200mm height options
- 50mm pitch slotted uprights

Height	Code	Price
1000mm	N001449	£120.00
1200mm	N001443	£124.00

## Tie Bars

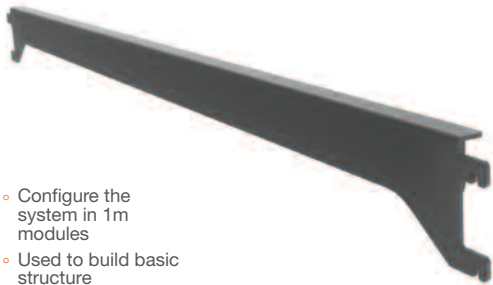

- Configure the system in 1m modules
- Used to build basic structure
- Minimum of either 2 bars or 2 fixed shelves per bay run
- Check individual products for tie bar requirements
- One tie bar can typically fit up to 6 eurohooks

Width	Code	Price
1000mm	N171219	£12.00

## Eurohooks

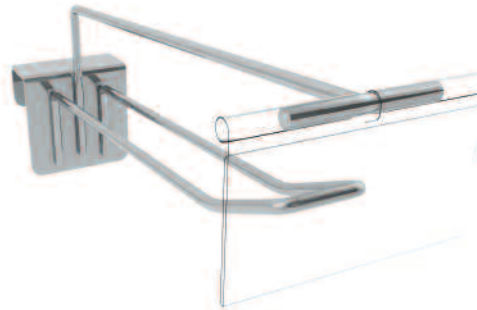

- Position anywhere along Tie Bars to provide hooks for bagged product

Length	Code	Price
200mm	K501724	£2.25

## Post Top Bowl

K003156



- Generate impulse sales
- Fits to the top of any Q+ upright
- Includes 4x 39mm SEL
- Petg construction

H: 125mm
W: 300mm
D: 300mm
Price: £38.87

## Corner Bowls (Single)

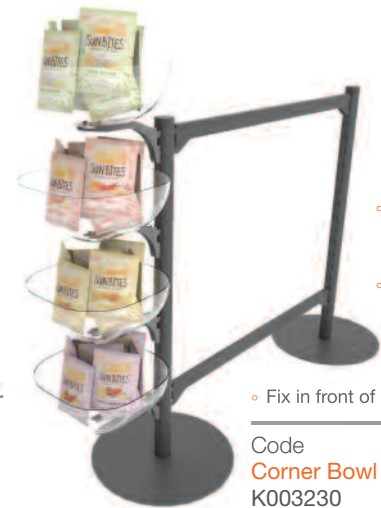

- Position anywhere up the Q+ upright and corner uprights
- Petg Construction

Code	Price
K003230	£52.00

Products highlighted green are available for next day despatch  
Please quote codes on all orders. Other sizes are available subject to quotation



## Confectionery Shelving

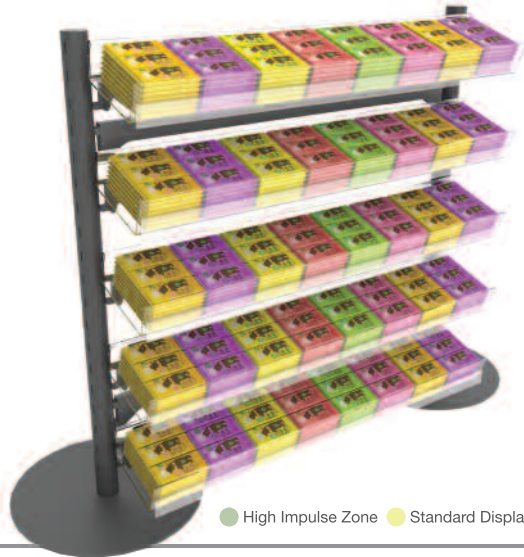

- Create a single or twin sided confectionery display
- Requires use of tie bars (N171219) or fixed width shelf e.g. Shop Through Shelves
- Petg Shelving
- Includes 39mm SEL
- x5 for 1000mm x6 1200mm

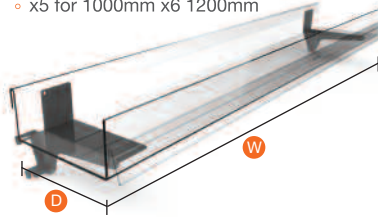

Shelf Depth  
Shelf Widths  
W 1000mm

D 165mm	D031831 £38.00
---------	-------------------

● High Impulse Zone ● Standard Display

## Shop Through Shelving



- Generate sales on both sides of the queue system
- Access product from both sides
- Various shelf widths available
- Petg Shelving
- Includes 2x 39mm SEL
- No tie bars required
- Ask our team about shelf dividers
- x4 for 1000mm x5 1200mm

● High Impulse Zone ● Standard Display

Shelf Depth  
Shelf Widths  
W 1000mm

D 140mm	D031829 £50.00
D 200mm	D031830 £55.00
D 300mm	D031824 £56.00

## Snack Shelving



- Create a single or twin sided snack display
- Fit up to 3 shelves on a 1000mm upright or 4 shelves on a 1200mm upright
- Petg Shelving
- Includes 39mm SEL
- No tie bars required

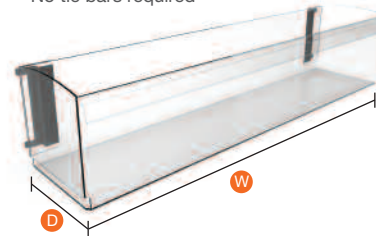

Shelf Depth  
Shelf Widths  
W 1000mm

D 200mm	E031407 £65.00
---------	-------------------

● High Impulse Zone ● Standard Display

## Shop Through Snacks



- Generate sales on both sides of the queue system
- Access product from both sides
- Petg Shelving
- Includes 2x 39mm SEL
- No tie bars required
- x2 for 1000mm x3 for 1200mm

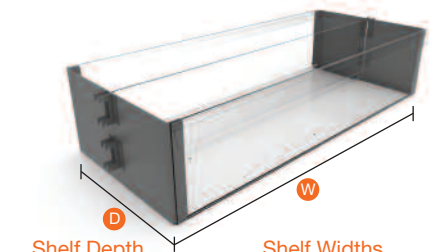

Shelf Depth  
Shelf Widths  
W 1000mm

D 380mm	E031409 £125.00
---------	--------------------

● High Impulse Zone ● Standard Display

Products highlighted green are available for next day despatch

Uprights not included

## Display Headers

Simply fit the interchangeable graphic headers to the top of the queue system to add impact to your display.



- Three width options allow you to fit them with or without promotional bowls in position
- Twin sided header sleeves allow continuous graphics throughout system



Code		Price
<b>A</b> Small (995mm)	K071608	£32.00
<b>B</b> Medium (1105mm)	K071607	£32.00
<b>C</b> Large (1210mm)	K071606	£32.00

Speak to our sales team about your configuration

## Magazine Shelf 100mm



- Position anywhere up the Q+ upright and corner uprights
- Requires use of tie bars (N171219) or fixed width shelf e.g. Shop Through Shelves
- Petg Shelving
- x3 for 1000mm & 12000mm

● Browsing Zone

Width	Code	Price
1000mm	A032375	£40.00

## Magazine Shelf 40mm (2T)



- Position anywhere up the Q+ upright and corner uprights
- Requires use of tie bars (N171219) or fixed width shelf e.g. Shop Through Shelves
- Petg Shelving
- x3 for 1000mm & 12000mm

● Browsing Zone

Width	Code	Price
1000mm	A032374	£53.00

## Shop Through Newspaper Shelf 60mm



- Position anywhere up the Q+ upright and corner uprights
- Requires use of tie bars (N171219) or fixed width shelf e.g. Shop Through Shelves
- Petg Shelving
- x2 for 1000mm x3 for 1200mm

● High Impulse Zone ● Browsing Zone

Width	Code	Price
1000mm	B031324	£65.00

## Newspaper Shelf 60mm



- Position anywhere up the Q+ upright and corner uprights
- Requires use of tie bars (N171219) or fixed width shelf e.g. Shop Through Shelves
- Petg Shelving
- x2 for 1000mm x3 for 1200mm

● High Impulse Zone ● Browsing Zone

Width	Code	Price
1000mm	B031323	£65.00

## A4 POS Holder

K003256



- Fits to the top of any Q+ upright
  - Sized to fit a simple A4 paper POS
  - Ideal to create 'queue here' signs or for product promotion
  - Petg Construction
- H: 297mm  
W: 210mm  
Price: £22.78

## Corner Graphics



- Position on the Q+ corner uprights
- Interchangeable graphic sleeves to be used with corner uprights which brings visuals impact to your queue management.
- Ideal for promotional branding opportunities or special offers
- Petg Construction

Height	Code	Price
1000mm	K003257	£25.00

Height	Code	Price
1200mm	K003251	£26.50

Corner Graphic Panel Tall (for use with display headers)

Products highlighted green are available for next day despatch  
Please quote codes on all orders. Other sizes are available subject to quotation

Graphics shown are not included

Prices shown are Recommended Retail Price (RRP) and subject to discount, contact sales for a quotation



# LED Under Shelf Lighting Proven to Increase Sales

The BARliteLED™ range of products, specialising in retail display lighting, is a high quality solution which brings a retail environment to life and creates a modern look to your store design whilst keeping running costs to a minimum.

Retail display lighting has proven to increase sales in many categories ranging from magazines, confectionery, wines and spirits to cosmetics. The BARliteLED™ product has many benefits including its slimline size which allows you to position this lighting in almost any display.

Using premium quality LED's, the BARliteLED™ system is guaranteed to bring your products to life.





## Illumination

These complete kits allow you to install LED illumination into many wall and gondola displays as supplied by Bartuf plus the majority of branded metal backing systems.

### Install up to 4 lights per bay

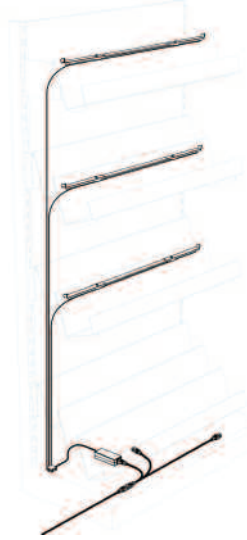

- Ideal for magazines and newspaper bays.
- This option brings your display to life using the minimum amount of components.
- Simply order the individual packs as detailed, for example, if you need 3 lights in your bay, order the triple lighting pack to the width required.

### Install up to 8 lights per bay

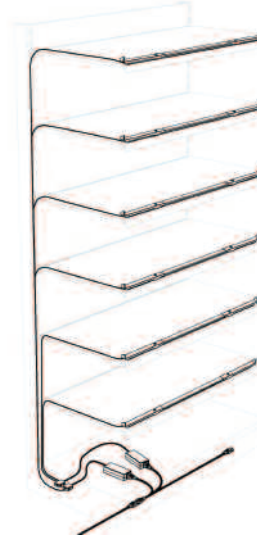

- Some displays require more than 4 lights per bay, such as confectionery and beers, wines and spirits. You can add up to 8 lights 1 bay using 2 lighting packs.
- For example, if you need 6 lights in one bay, order two triple lighting packs to the width required.

### Linking bays together

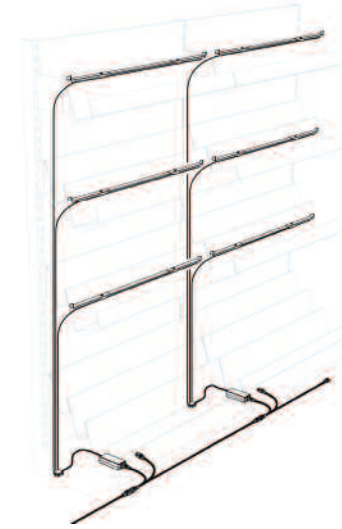

- The three way mains power linking lead (supplied with all packs) allows you to run up to two lighting packs per bay and also link your mains power to an adjacent bay.
- You can run up to 6 bays all running quad lighting packs from one 13AMP socket.

The brackets supplied with these packs fit the shelving brackets on magazine, newspaper, confectionery, greeting cards and metal shelf displays. There are 3 sizes of fitting available which give the options to fit bay widths from 600mm to 1330mm.

Available as either single, twin, triple or quad LED light fittings to suit the application.

Very simple to install, these LED lighting packs can easily be linked together to allow you to run up to 6 consecutive bays from one 13AMP socket.

For more detail on the BARliteLED™ system visit [www.barliteled.co.uk](http://www.barliteled.co.uk)

### What's included...?

- LED light bars and low voltage power leads
- 240v to 12v transformer with 4 way low voltage power distribution
- 3 way mains power linking lead
- Mains power lead
- Pair of wall/gondola display fixing brackets per LED light bar
- Cable management conduit

No. of	Bay Widths		
	600-800mm (lightbar length 500mm)	900-1000mm (lightbar length 750mm)	1200-1330mm (lightbar length 1050mm)

Single	L011061 £81.75	L031077 £101.65	L041067 £103.95
Twin	L011062 £122.65	L031078 £146.00	L041068 £150.70
Triple	L011063 £151.85	L031079 £186.90	L041069 £195.10
Quad	L011064 £198.60	L031080 £245.30	L041070 £257.00

### Top Tier Illumination

The top tier illumination bracket provides a unique product enhancement solution for the top section of your magazine bay. The lights are extremely easy to install and can run in series with standard BARliteLED's (BARliteLED not included). A protective top cap is included that both protects the light and prevents any magazines falling down the back of the system.

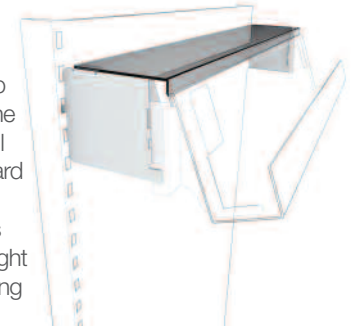

600mm	L011006	£27.35	1200mm	L041007	£31.00
650mm	L071022	£27.35	1250mm	L051001	£31.00
900mm	L021006	£29.20	1330mm	L061001	£32.45
1000mm	L031006	£29.20			

Products highlighted green are available for next day despatch  
Please quote codes on all orders. Other sizes are available subject to quotation

Prices shown are Recommended Retail Price (RRP) and subject to discount, contact sales for a quotation

# Trust Bartuf

## For all your retail display solutions

FORE have enjoyed a lasting and successful partnership with Bartuf and are delighted with their innovative design approach and use of technology. Their willingness to change and be flexible has resulted in Bartuf becoming the market leading provider of News category fixture solutions to meet our clients' needs

Richard Smith, Fore UK

The Flexi-News display that we put into our West Horndon store has been a great success and I think is a real step-change in terms of displaying titles in our stores.

Rosanna Cook, McColls

'LED lights have made a huge difference both in brightening up the store and increasing confectionery sales by over 8%'

Joe Rushton, Director, Towlers Ltd

All product designs are protected by design rights & copyright© Patents: GB 2293538B, GB2317328, US 6,112,912

**Bartuf**<sup>®</sup>  
Quality Retail Solutions

0845 130 2266  
[www.bartuf.com](http://www.bartuf.com)

**Bartuf Ltd.**  
Carr Crofts Drive  
Leeds  
LS12 3AL

T 0113 244 5524  
F 0113 244 6664  
E [sales@bartuf.com](mailto:sales@bartuf.com)

