

HARTE

CONCEPT • DESIGN • DELIVERED

THE EXCLUSIVE COMIC BOOK

LIMITED EDITION



DELIVERING THE ULTIMATE MISSION

THE COMPLETE STORY OF THE DARING
EXPLOITS OF A SUPER SHOPFITTER !!

CHECKOUTS



Get the wow factor

PREMIUM RANGE
GREAT LOOKS



Space Saving



Express



Build your customised specification

We offer a huge range of extras for our checkouts. From accessory units to metalworks:- bag dispensers, EPOS posts, supply poles to counter cache.

All your needs built into the checkout at the initial stage reducing hassle and stress on site!

VALUE ENGINEERED
FOR THE PRICE CONSCIOUS



Magazine & Confectionery displays

CONTINUED.....



KIOSK STORY

WE ARE CONSTANTLY
DELIVERING NEW PRODUCTS
& IDEAS ALONGSIDE OUR
.....CUSTOMERS.....

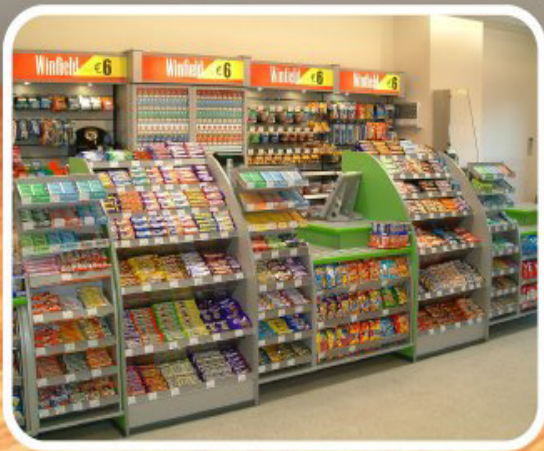

CONTINUED.....

DESIGN A COUNTER...

START WITH A BASIC STYLE COUNTER

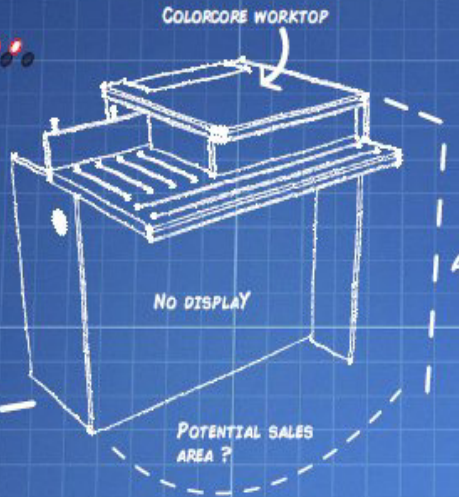
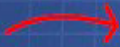
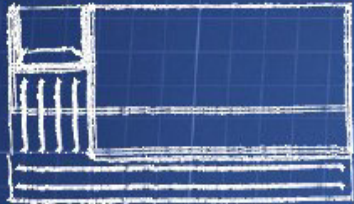

CUSTOMIZE YOUR COLOUR SPECIFICATION & MATERIALS



WORKTOP FINISH TO SUIT YOUR INDIVIDUAL REQUIREMENTS



SOME OF THE EXTRAS WE CAN SUPPLY
 OPERATOR & CUSTOMER DISPLAY STANDS,
 CHIP & PIN STANDS, SOCKETS & TRUNKING
 CARRIER BAG DISPENSERS,
 COUNTER CACHE.....AND MUCH MORE



TROLLEY CORRAL COUNTER (A HARTE DESIGNED PRODUCT)

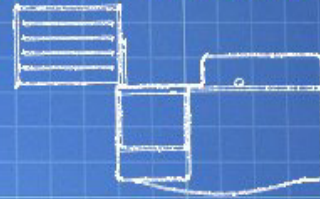

CONCEPT

ALONG THE WAY !!



HALF WAY !

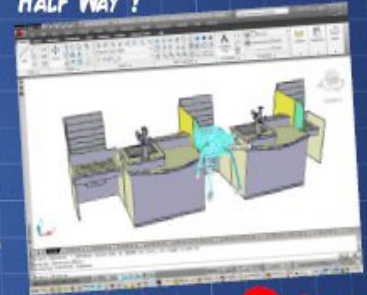

DESIGN

INNOVATIVE MARKET FIRST



DELIVERED



THE FIRST ERGONOMIC TROLLEY BASKET OPERATIONAL COUNTER !

CONTINUED.....

...OPTICIANS...



"DISPLAY WALLS"



"RECEPTION DESK"



"FULL SHOPFITTING SERVICE"



"STORAGE"

...HIGH STREET...



"LUXURY EPOS TILL"



"LUXURY DISPLAY COUNTERS"

...SHOPPING CENTRES...



SALES DESKS WITH BRAND RECOGNITION

MOBILE DISPLAY UNITS



DELI COUNTERS



POST OFFICE

Q-ING SYSTEM

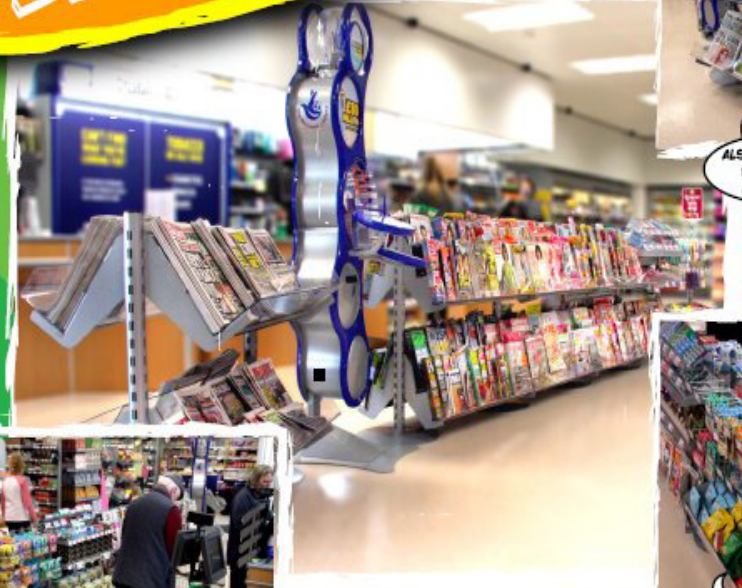

ALSO MAGAZINE & TROUGH AVAILABLE



BINNING TROUGHS & SHELVES

CIG RUSHERS



ROLLER SHUTTERS

FLAP-SYSTEMS

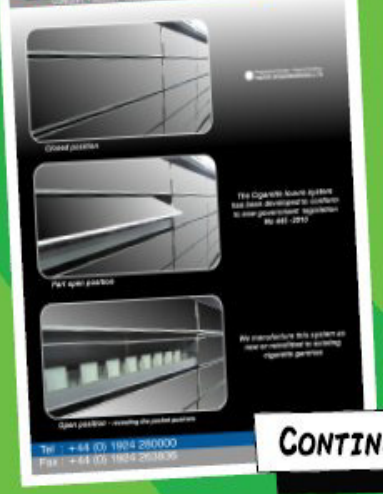

CONTINUED.....

THE END..... (FOR NOW) !!



CORPORATE RESPONSIBILITY

IT IS OUR LONG-STANDING POLICY TO CONDUCT BUSINESS IN A MANNER THAT CONSIDERS BOTH THE ENVIRONMENTAL AND ECONOMIC NEEDS OF THE MARKETS IN WHICH WE OPERATE. WE SEEK TO OPERATE IN A MANNER THAT IS NOT HARMFUL TO THE ENVIRONMENT, WHILE CONSTANTLY LOOKING TO OFFER THE CUSTOMER A QUALITY PRODUCT AT THE BEST PRICE. AT HARTE WE ARE EXTREMELY CONSCIOUS OF CURRENT AFFAIRS WITH REGARDS TO THE ENVIRONMENT AND HAVE TAKEN STEPS IN REDUCING OUR CARBON FOOTPRINT. AS A COMPANY WE ARE FSC[®] ACCREDITED WHICH PROVIDES US AS A GROUP WITH A CREDIBLE SOLUTION TO COMPLEX ENVIRONMENT AND SOCIAL ISSUES SUCH AS RECYCLING, REDUCING CARBON EMISSIONS AND REGENERATING OUR FORESTS.

AS A COMPANY WE BELIEVE A SUSTAINABLE FUTURE NOT ONLY GUARANTEES OUR BUSINESSES FUTURE BUT MOST IMPORTANTLY CUSTOMER SATISFACTION.



SALES GANG OUR SALES TEAM WILL STRIVE TO FULFIL YOUR REQUIREMENTS !! www.harte.co.uk

FRASER THOMSON



COMMERCIAL DIRECTOR

BRIAN THOMSON



SALES MANAGER

DAN CHALKEY



SALES CONSULTANT

DEREK CHALMERS



SALES CONSULTANT

BOB DRYDEN



SALES CONSULTANT

LOCATION DETAILS



Harte Woodworking
Springfield Mill, Spa Street
Ossett
West Yorkshire
WF5 0HW

DIRECTIONS



WEB SITE



Download **SCAN** on your smartphone today